

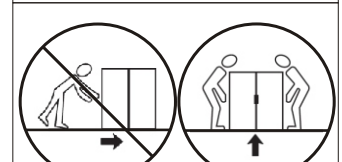

Producent: **MEBLE OKMED** POLAND
 POLSKA 14-500 Braniewo ul. Kolejowa 13
 www.mebleokmed.pl tel. (+48) 55 243-02-41

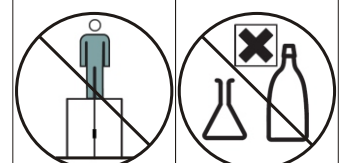
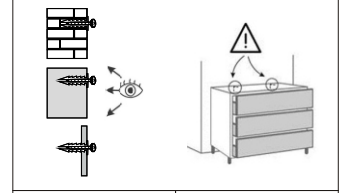
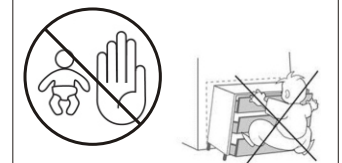
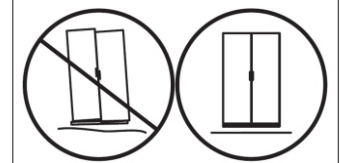
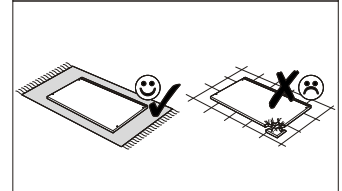
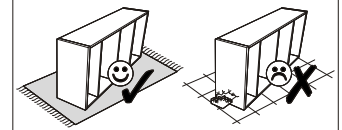
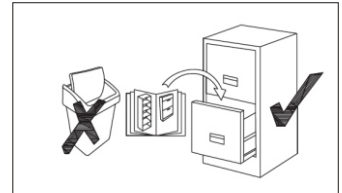
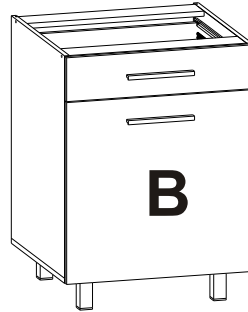
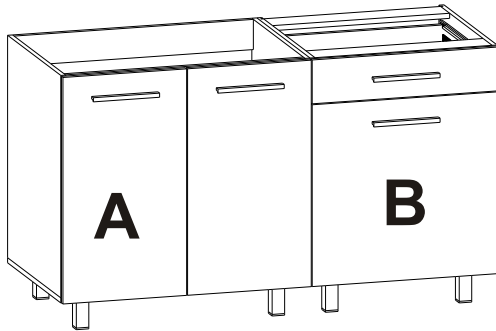
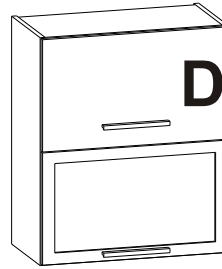
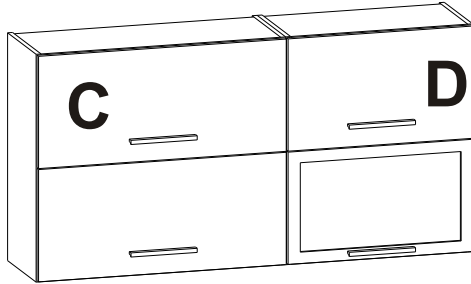
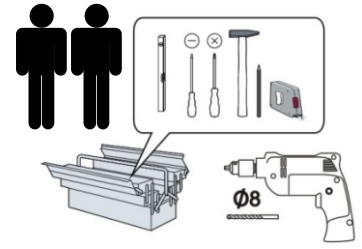

1/6 A		
1	16x700x560	X1
2	16x700x560	X1
3	16x800x560	X1
4	16x767x95	X1
5	16x767x95	X1
6	16x767x95	X1
7	16x713x396	X1
8	16x713x396	X1

2/6 B		
9	16x700x560	X1
10	16x700x560	X1
11	16x600x560	X1
12	16x567x95	X1
13	16x567x95	X1
14	3x705x290	X1
15	3x705x290	X1
16	16x537x498	X1
17	16x537x69	X1
18	16x138x596	X1
19	16x570x596	X1
20	16x567x522	X1

3/6 B		
9	16x700x560	X1
10	16x700x560	X1
11	16x600x560	X1
12	16x567x95	X1
13	16x567x95	X1
14	3x705x290	X1
15	3x705x290	X1
16	16x537x498	X1
17	16x537x69	X1
18	16x138x596	X1
19	16x570x596	X1
20	16x567x522	X1

4/6 C		
21	16x717x300	X1
22	16x717x300	X1
23	16x767x282	X1
24	16x767x282	X1
25	16x767x282	X1
26	3x785x355	X1
27	3x785x355	X1
28	16x353x796	X1
29	16x353x796	X1

5/6 D		
30	16x717x300	X1
31	16x717x300	X1
32	16x567x282	X1
33	16x567x282	X1
34	16x567x282	X1
35	3x355x582	X1
36	3x355x582	X1
37	16x353x596	X1
38	22x353x596	X1

6/6 D		
30	16x717x300	X1
31	16x717x300	X1
32	16x567x282	X1
33	16x567x282	X1
34	16x567x282	X1
35	3x355x582	X1
36	3x355x582	X1
37	16x353x596	X1
38	22x353x596	X1

1/6		A
1	16x700x560	X1
2	16x700x560	X1
3	16x800x560	X1
4	16x767x95	X1
5	16x767x95	X1
6	16x767x95	X1
7	16x713x396	X1
8	16x713x396	X1

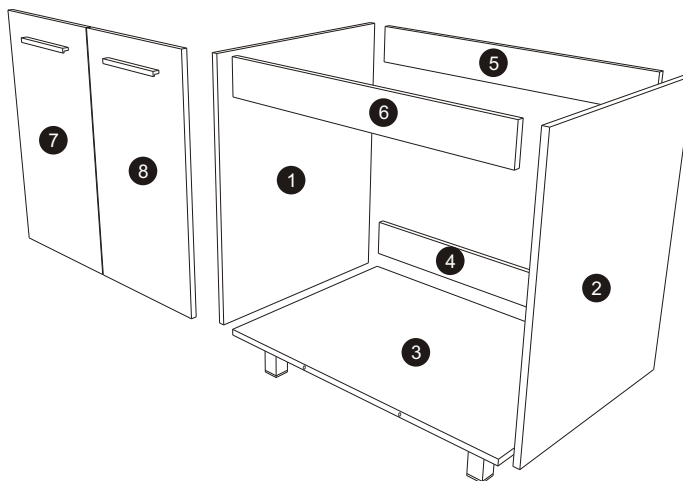

2/6 3/6		B
9	16x700x560	X1
10	16x700x560	X1
11	16x600x560	X1
12	16x567x95	X1
13	16x567x95	X1
14	3x705x290	X1
15	3x705x290	X1
16	16x537x498	X1
17	16x537x69	X1
18	16x138x596	X1
19	16x570x596	X1
20	16x567x522	X1

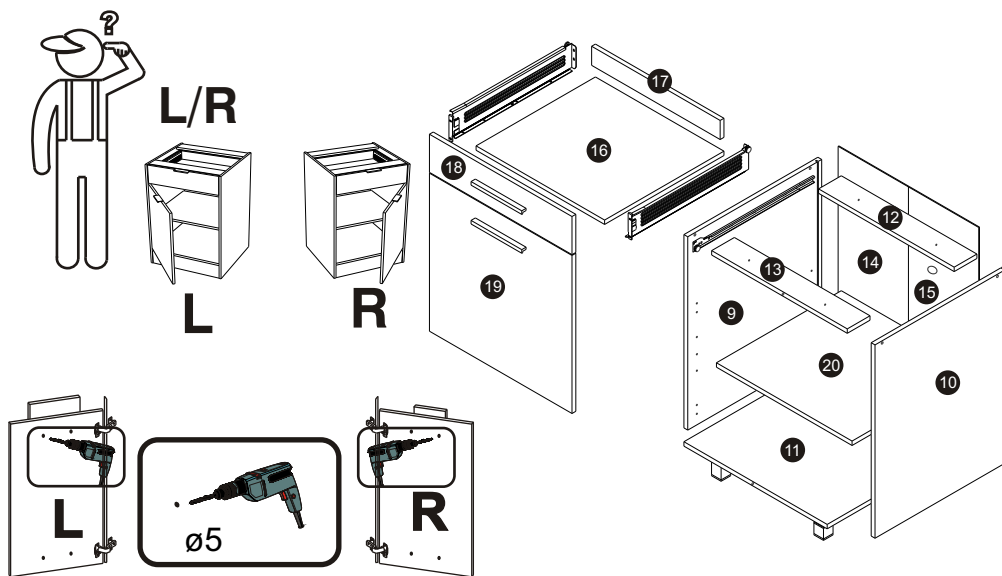

4/6		C
21	16x717x300	X1
22	16x717x300	X1
23	16x767x282	X1
24	16x767x282	X1
25	16x767x282	X1
26	3x785x355	X1
27	3x785x355	X1
28	16x353x796	X1
29	16x353x796	X1

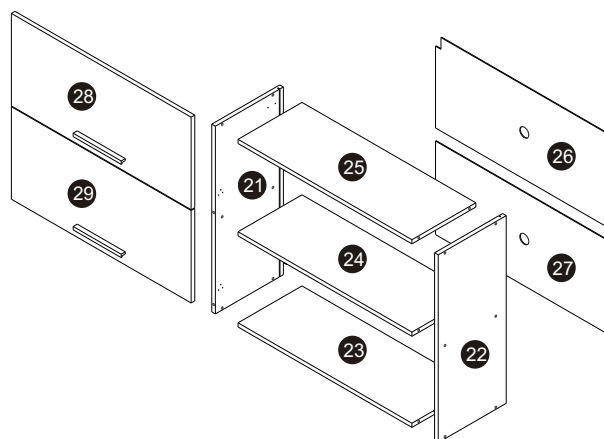

5/6 6/6		D
30	16x717x300	X1
31	16x717x300	X1
32	16x567x282	X1
33	16x567x282	X1
34	16x567x282	X1
35	3x355x582	X1
36	3x355x582	X1
37	16x353x596	X1
38	22x353x596	X1

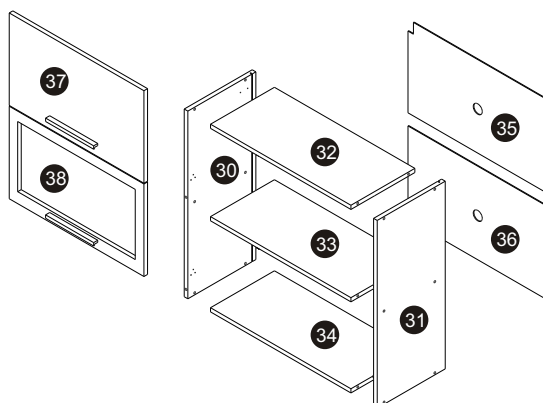

1/6		A
1	16x700x560	X1
2	16x700x560	X1
3	16x800x560	X1
4	16x767x95	X1
5	16x767x95	X1
6	16x767x95	X1
7	16x713x396	X1
8	16x713x396	X1

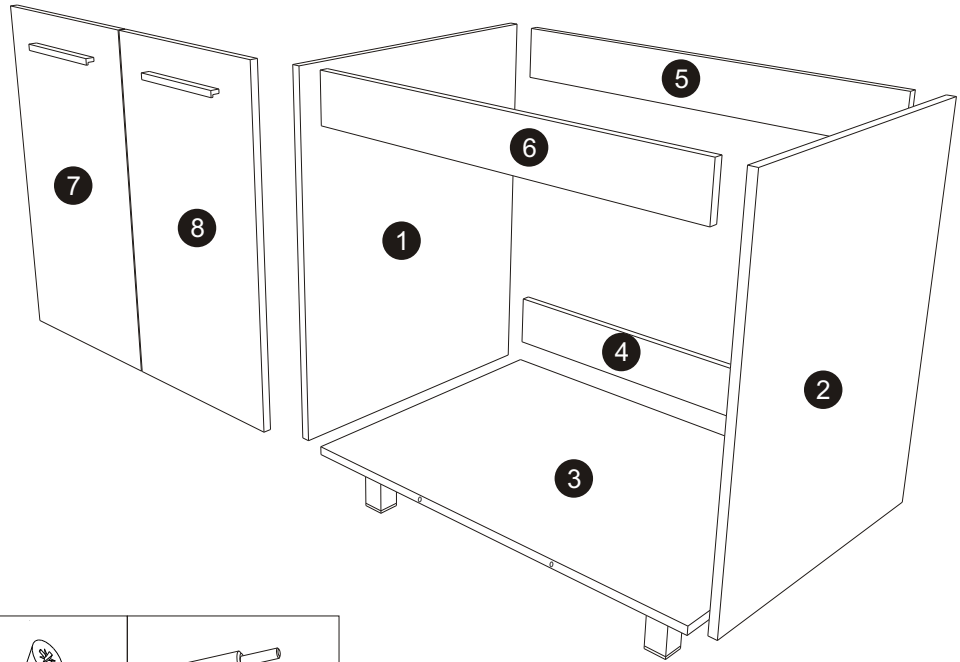

		X4		X8		X2					
ZP	Z1P		W4		AM1						
	X1		X12		X6		X4		X4		X2
KK1		K1		ZK		KD1		WU		U75	
	X4		X4		X16		X4		X4		X8
SR5		NA1		W11		ZM1		PMO1		W12	

01

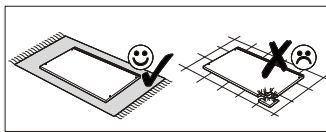

	X4			X4
KD1		ZP	Z1P	

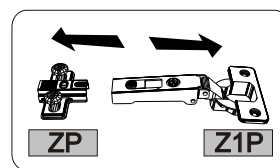

	X4
ZP	

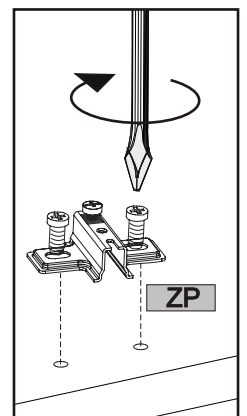
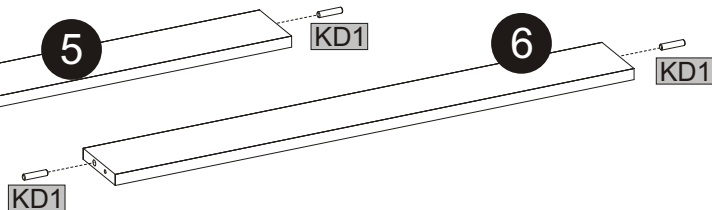
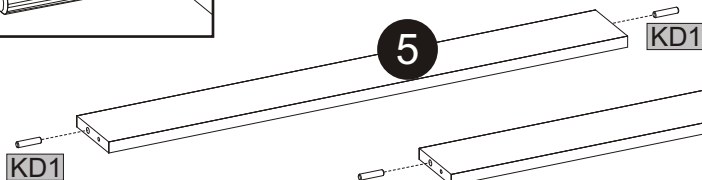
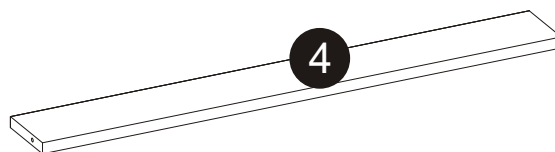
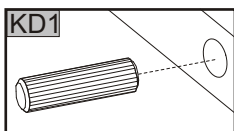
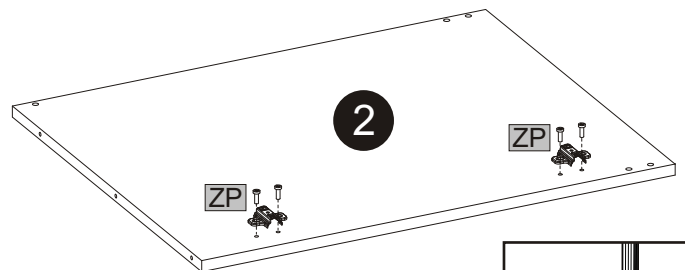
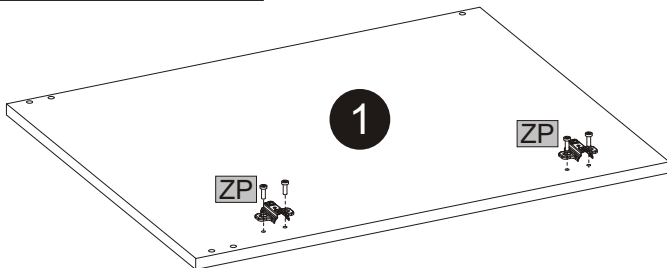

02

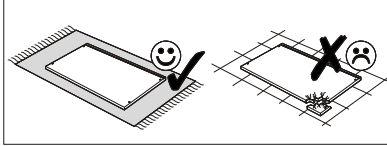

KK1	X1	K1
X1	X12	ZK
		X6

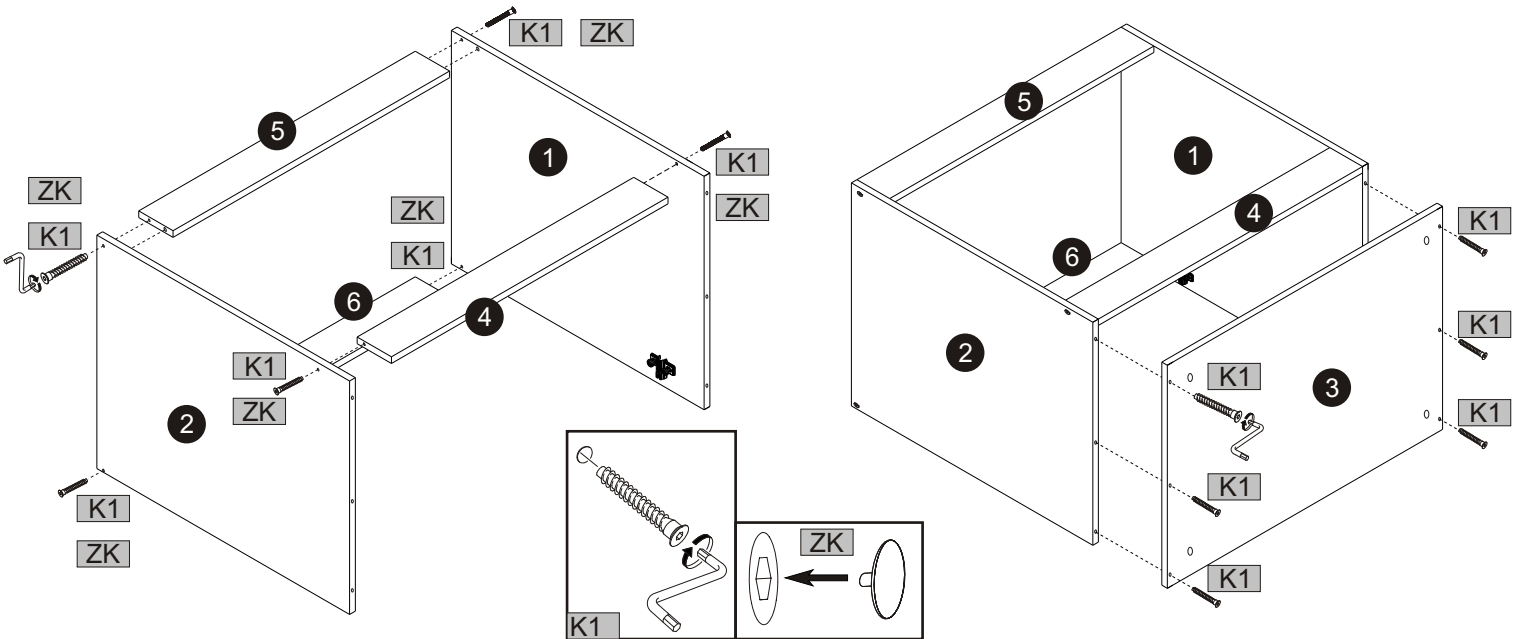

03

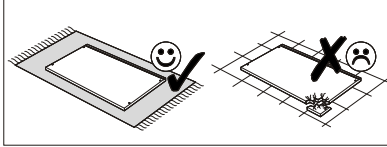

SR5	X4	NA1	W11
X4	X4		X16

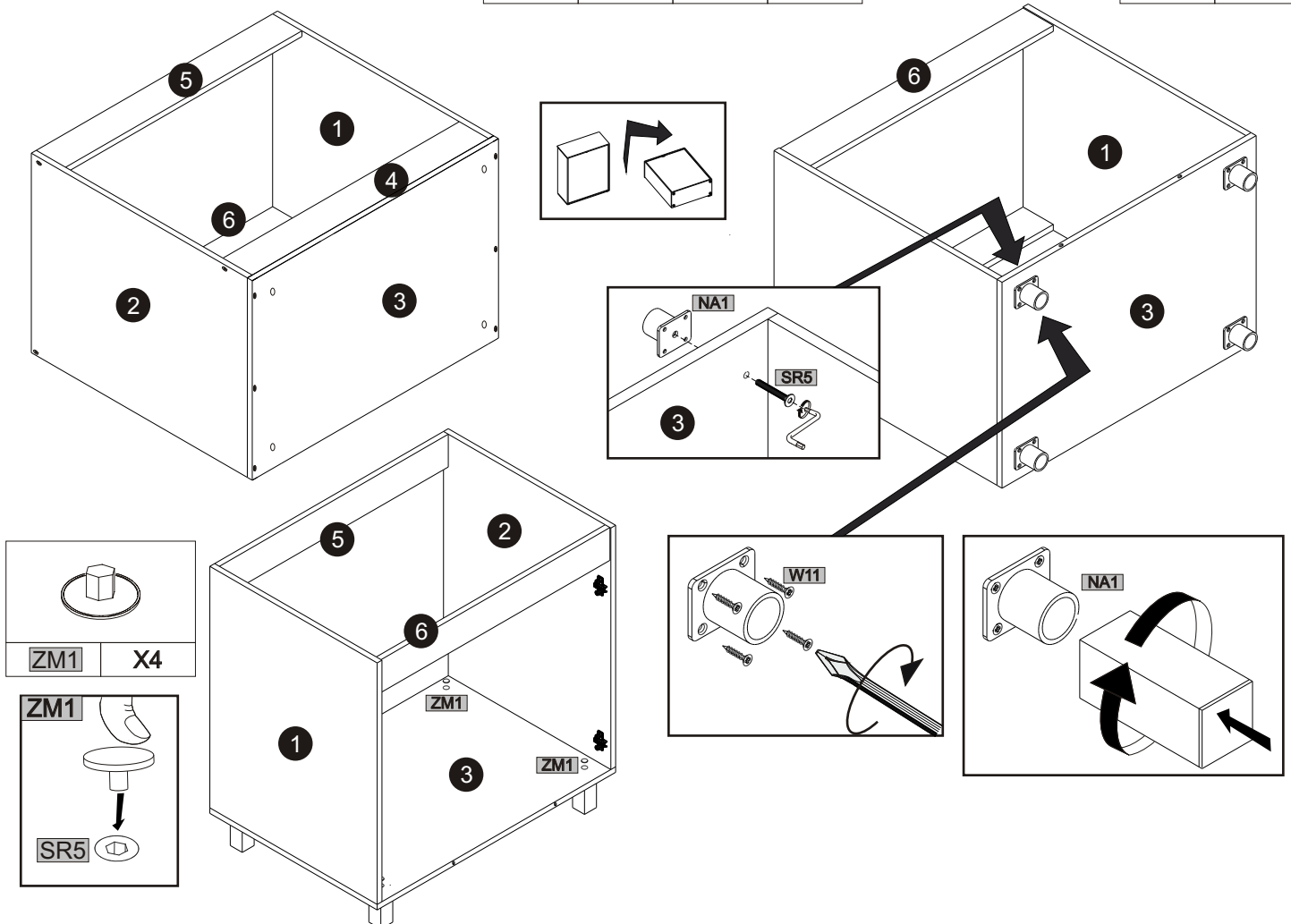

04

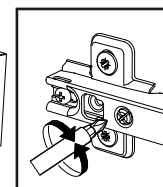
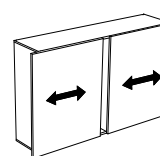
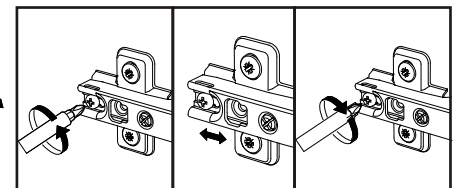
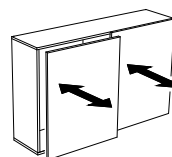
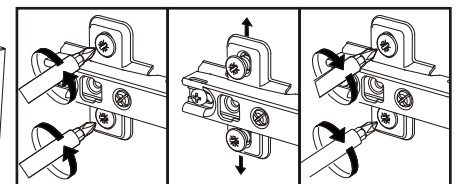
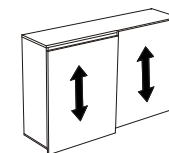
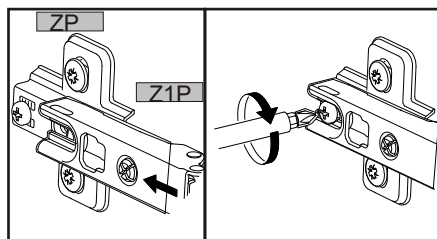
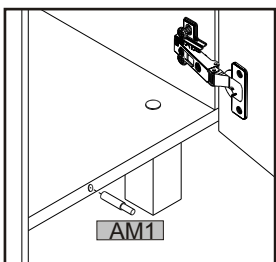
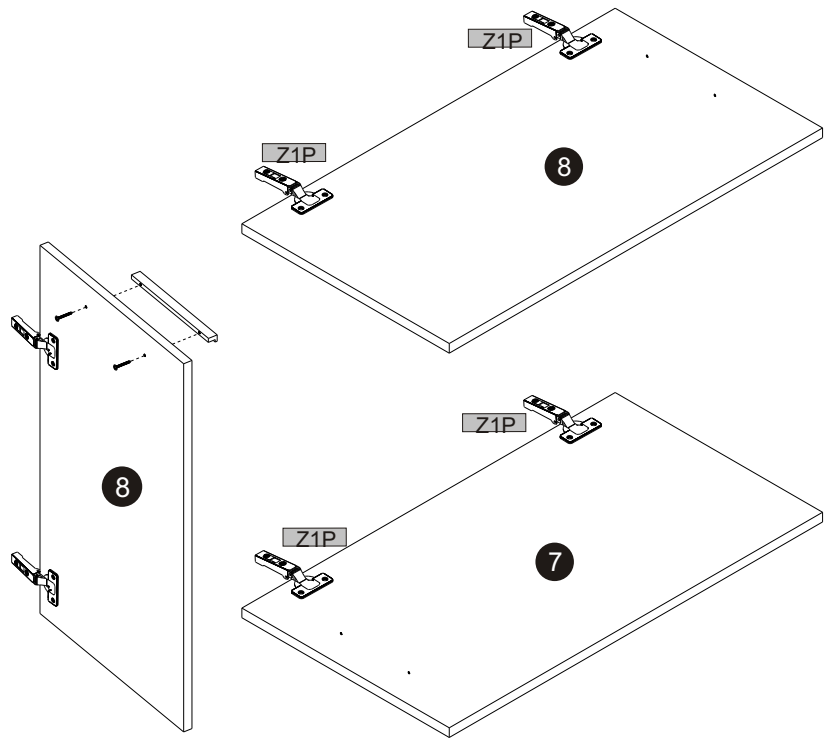
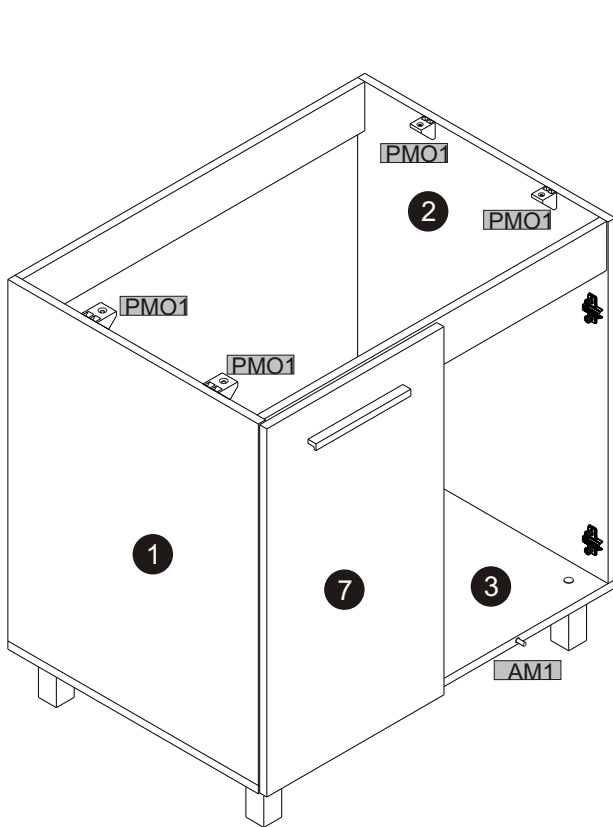
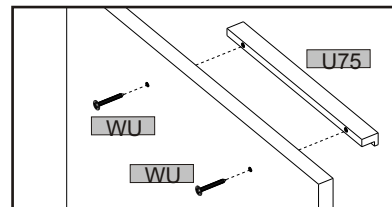
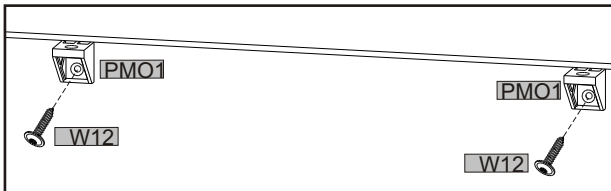
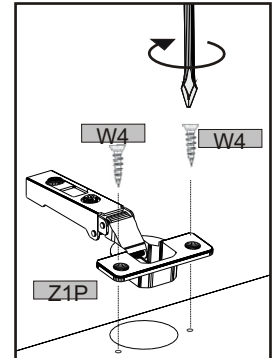
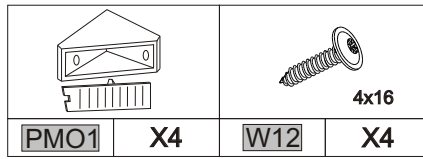
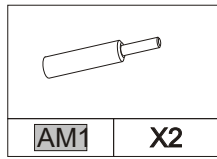
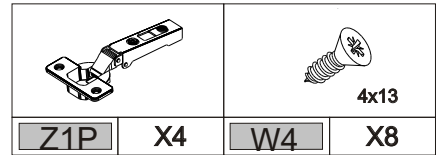
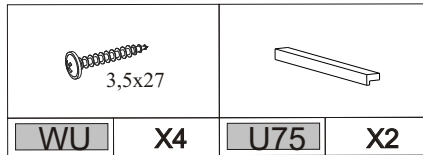
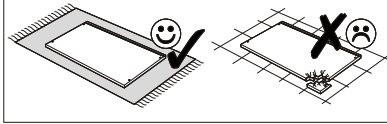

	2/6	3/6	B
9	16x700x560	X1	
10	16x700x560	X1	
11	16x600x560	X1	
12	16x567x95	X1	
13	16x567x95	X1	
14	3x705x290	X1	
15	3x705x290	X1	
16	16x537x498	X1	
17	16x537x69	X1	
18	16x138x596	X1	
19	16x570x596	X1	
20	16x567x522	X1	

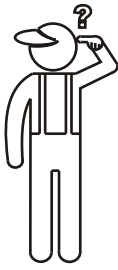

L/R

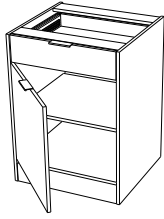

L

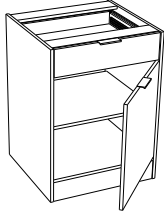

R

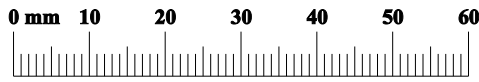
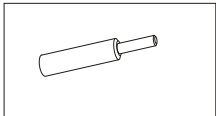
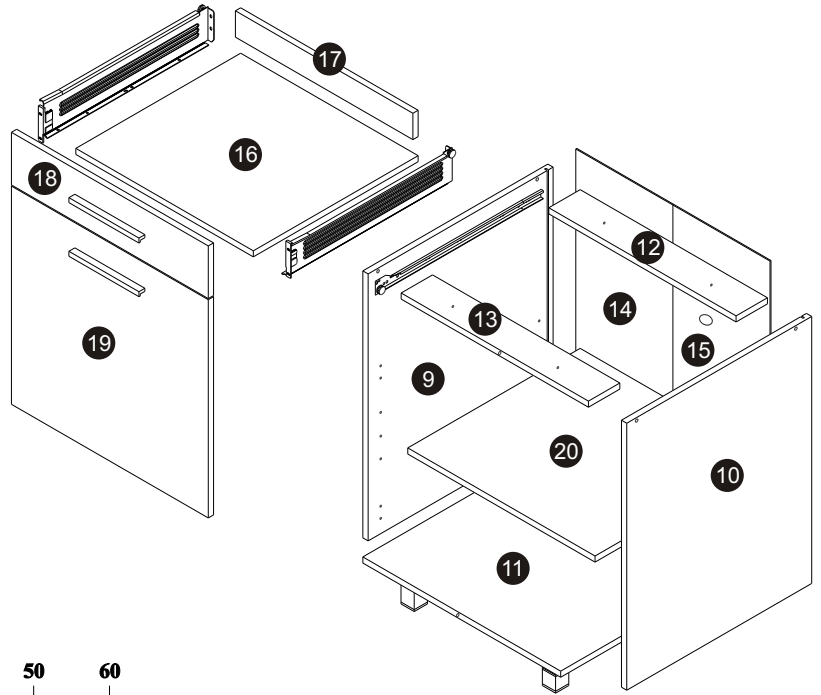

AM1 X2

KK1 X1	K1 X10	ZK X4	W1 X8	WU X4	U75 X2
SR5 X4	NA1 X4	W11 X36	ZM1 X4	W7 X4	S1 X6
PP X4	PMT2 X1	LI X1	WK1 X1	W4 X4	ZP X2

01

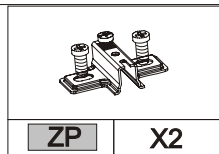
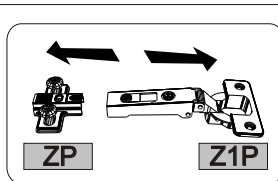
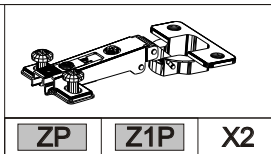
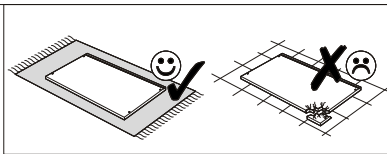

L/R

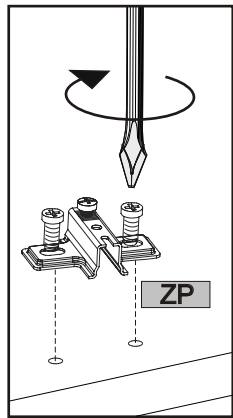
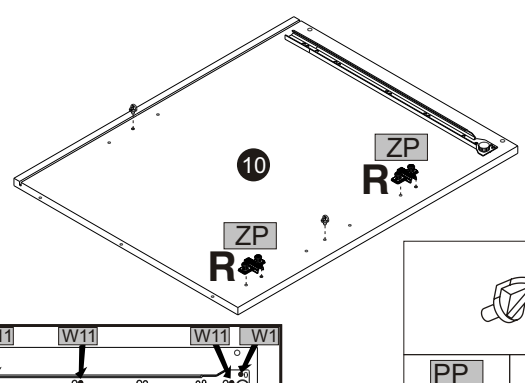
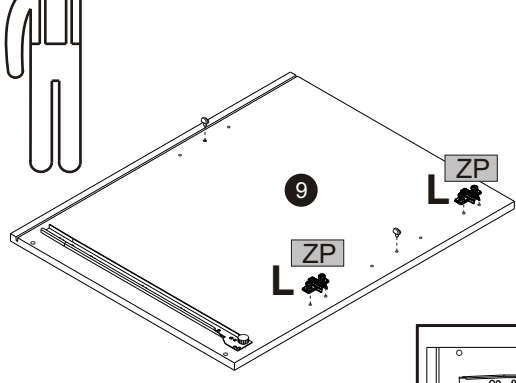

PMT2 X1	W1 X2	W11 X6

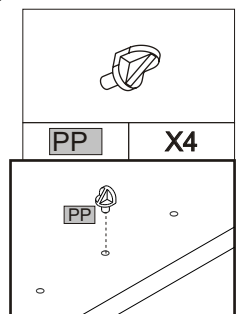
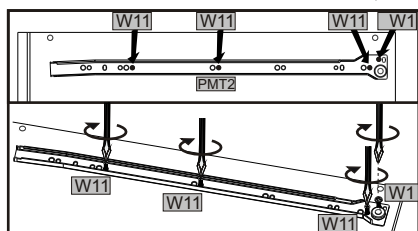

PP X4

02

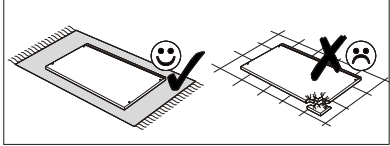

			7x50
KK1	X1	K1	X10
ZK	X4		

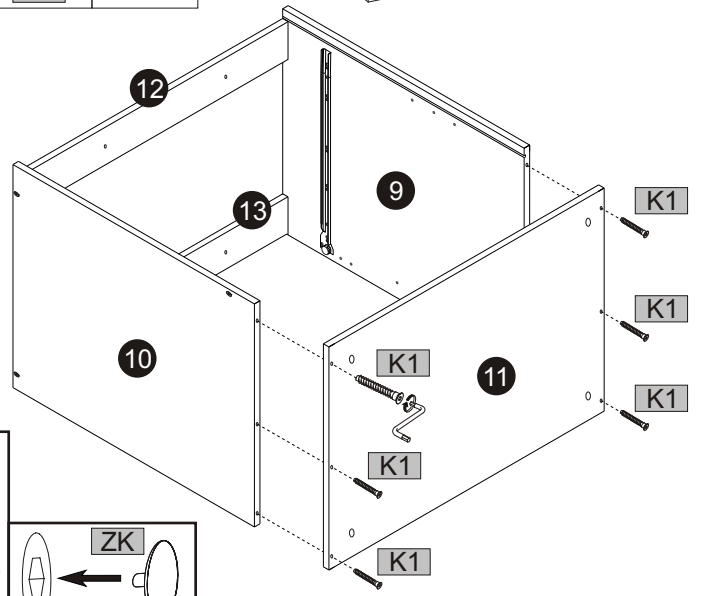
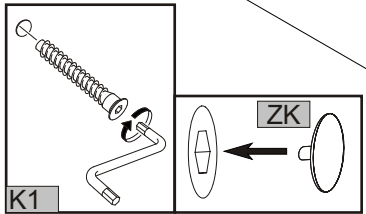
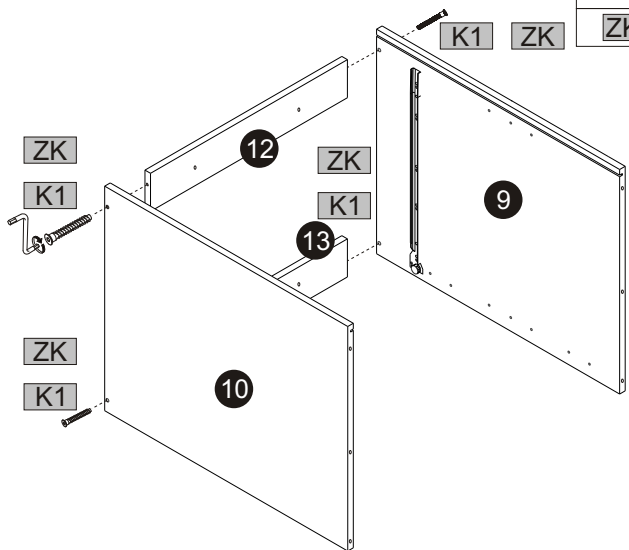
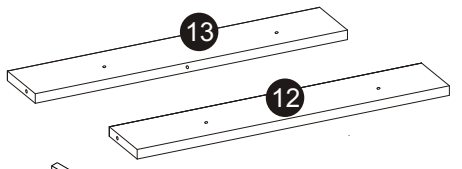

03

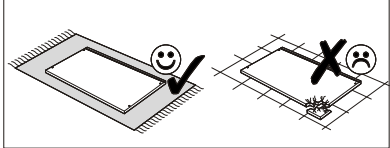

SR5	X4	NA1	X4

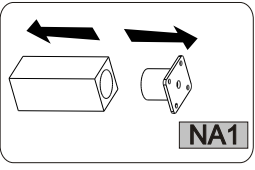

	3,5x16
W11	X16

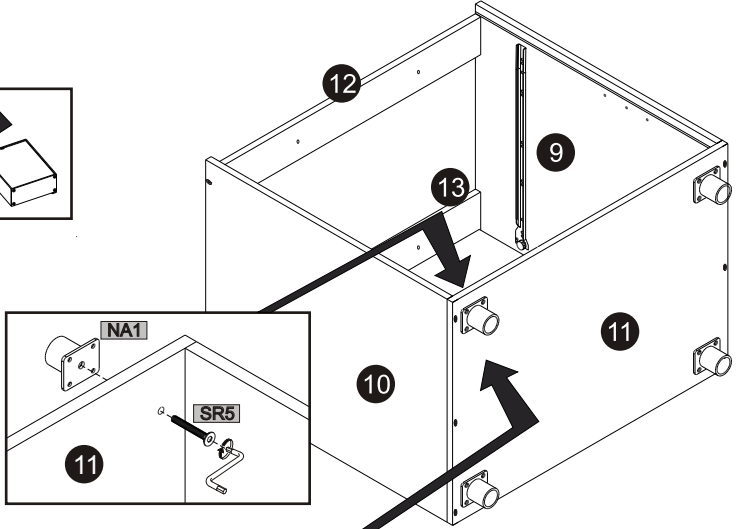
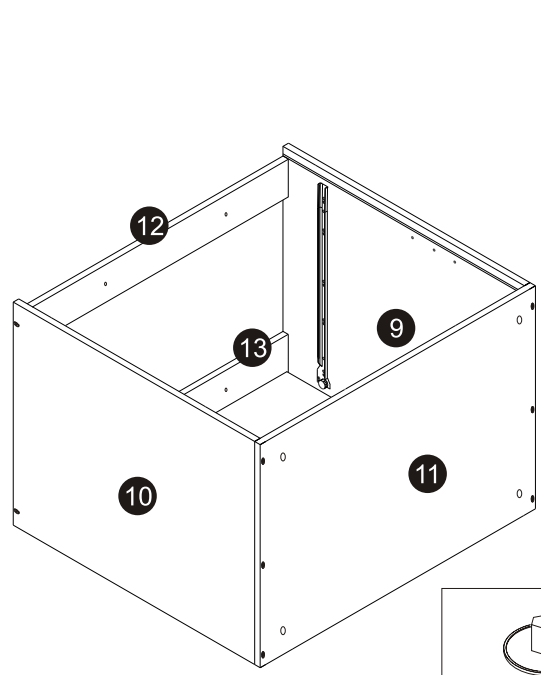
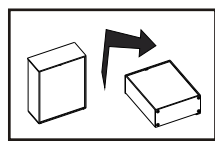

ZM1	X4

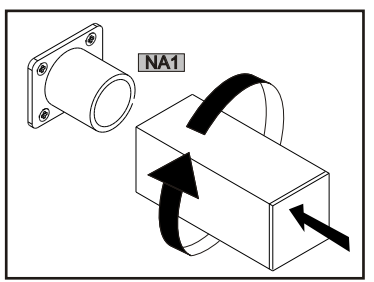
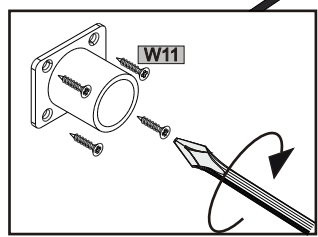
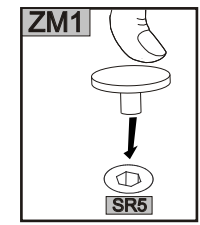

04

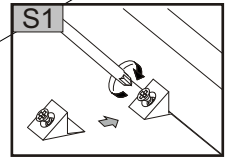
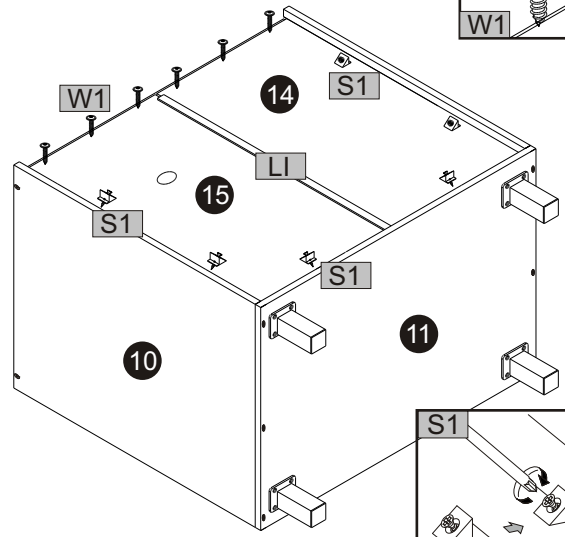
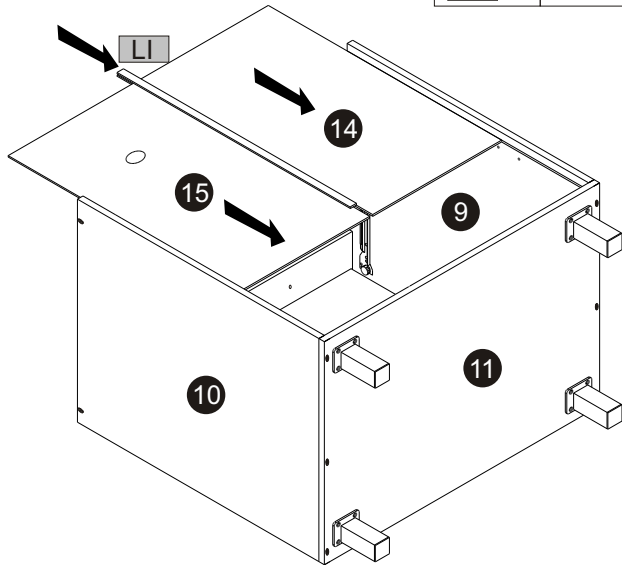
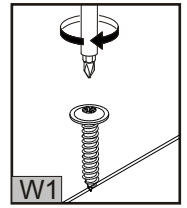
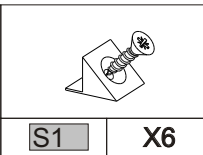
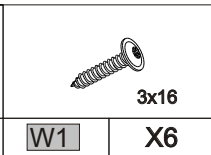
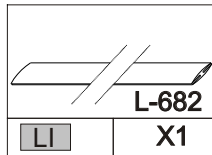
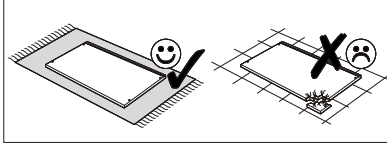

05

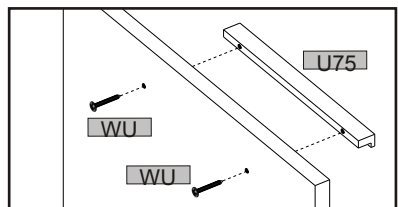
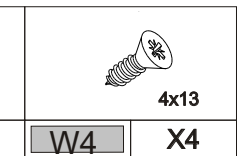
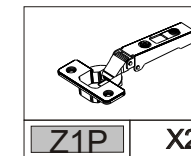
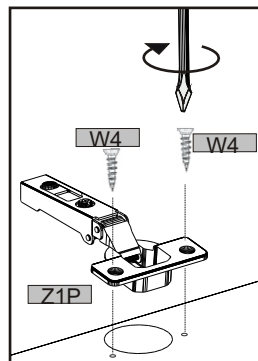
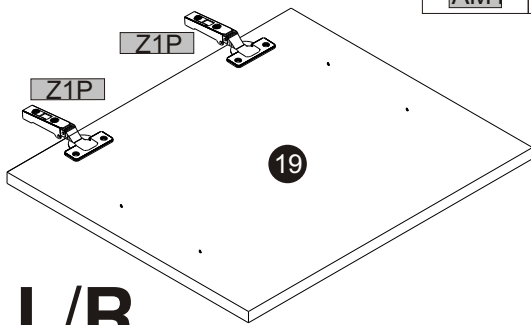
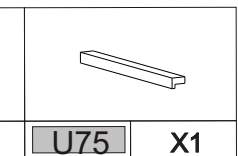
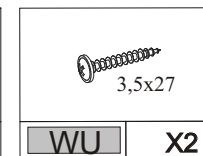
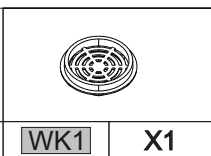
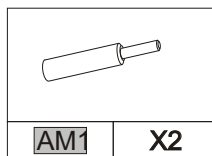
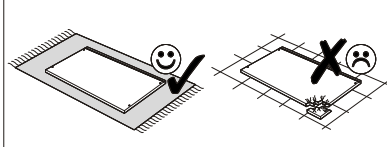

L/R

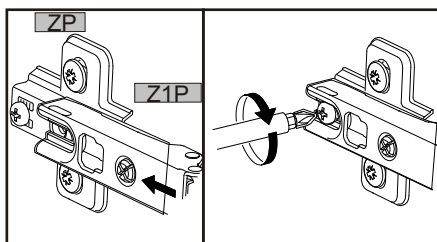
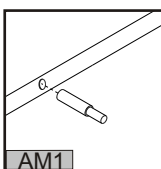
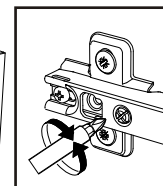
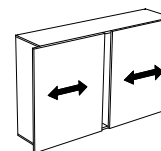
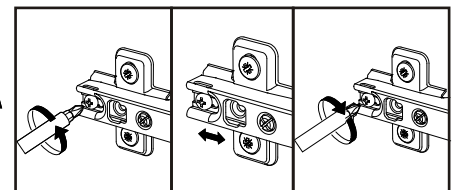
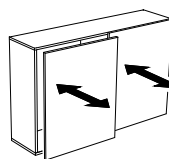
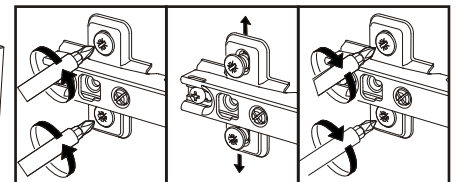
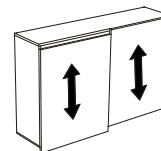
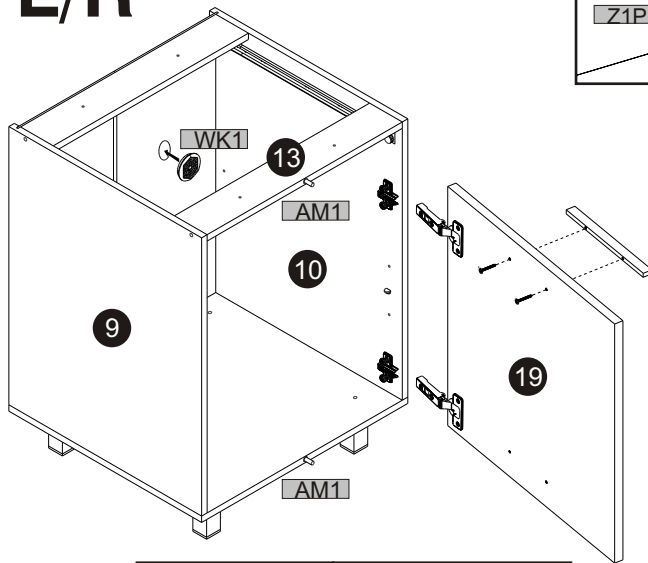

06

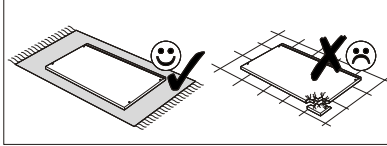

3,5x16	PMT2	3,5x27	U75
W11	X14	WU	X2
			X1

3,5x27	U75
WU	X2
	X1

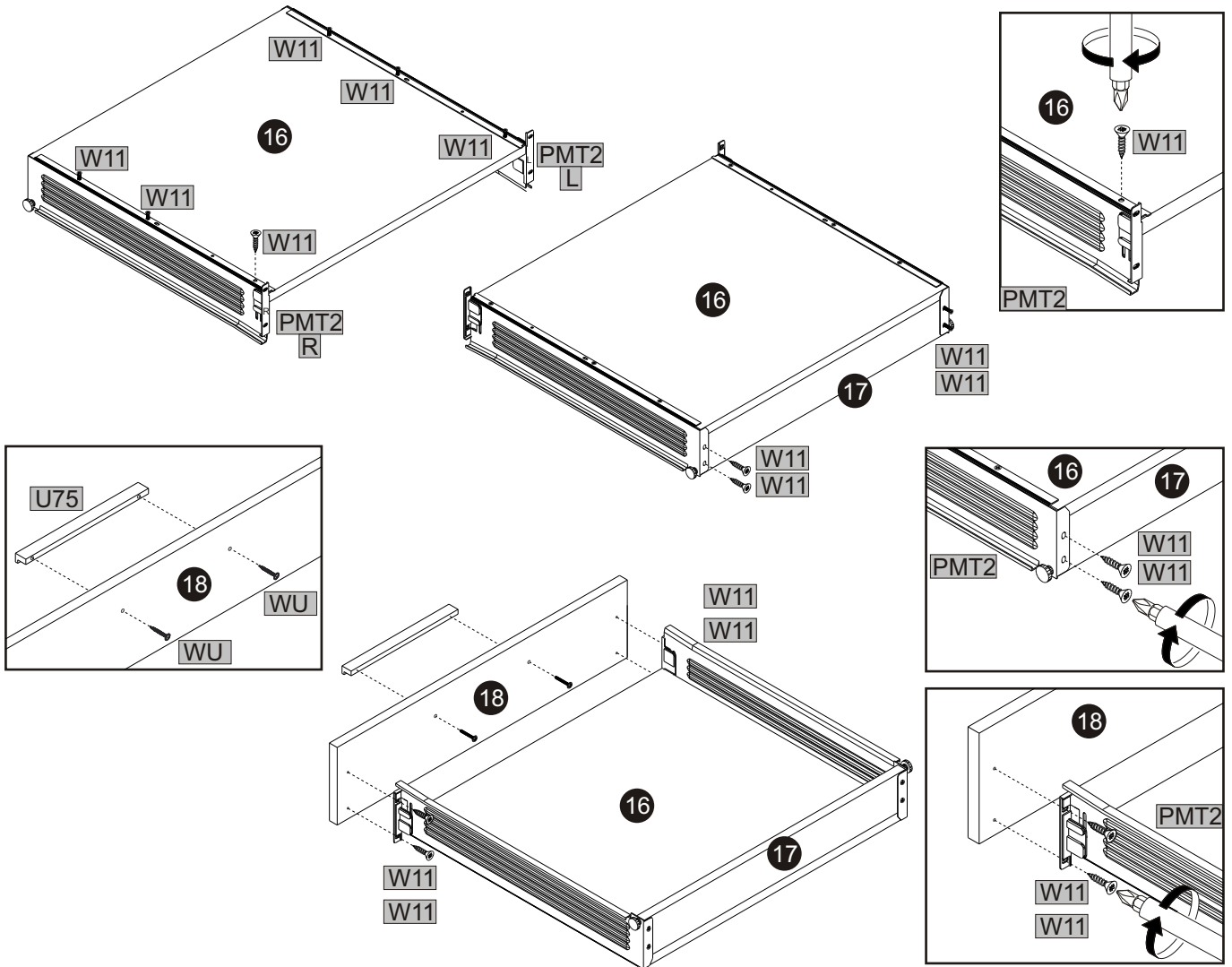

07

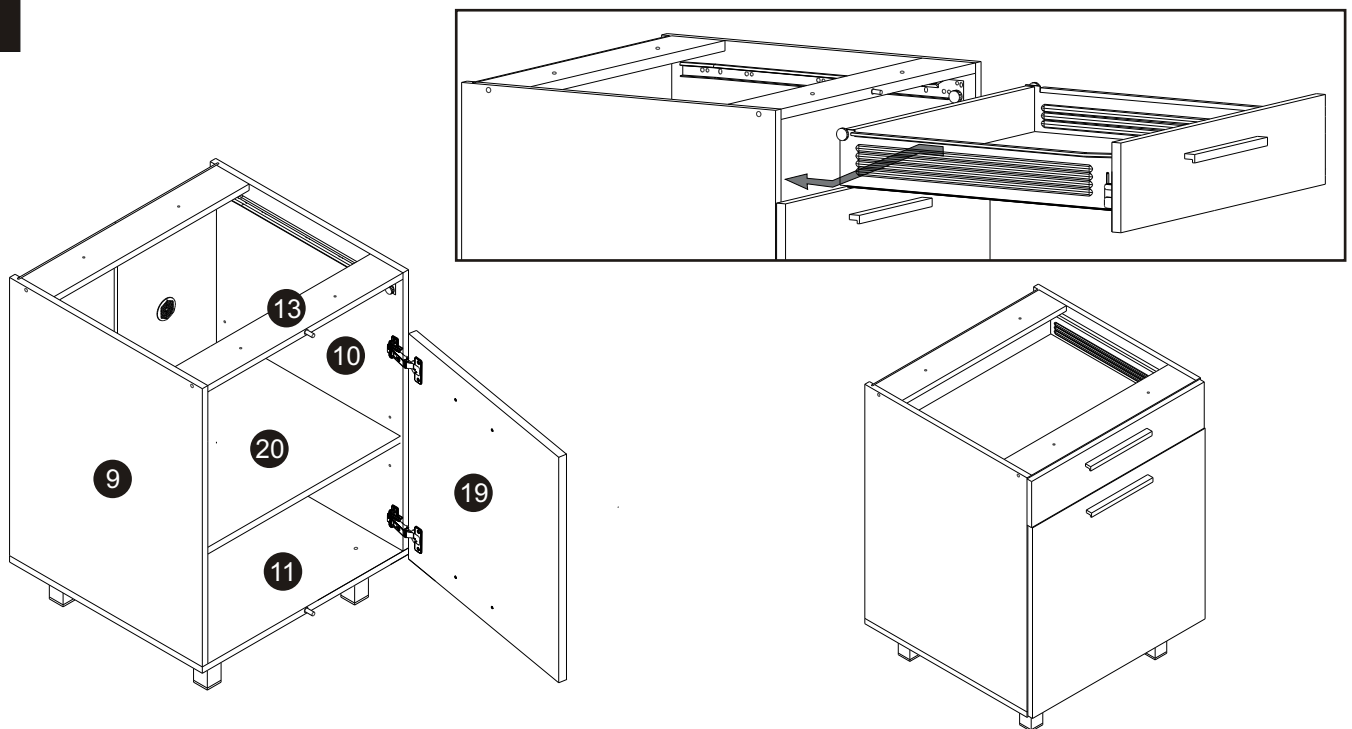

4/6		C
21	16x717x300	X1
22	16x717x300	X1
23	16x767x282	X1
24	16x767x282	X1
25	16x767x282	X1
26	3x785x355	X1
27	3x785x355	X1
28	16x353x796	X1
29	16x353x796	X1

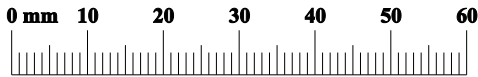
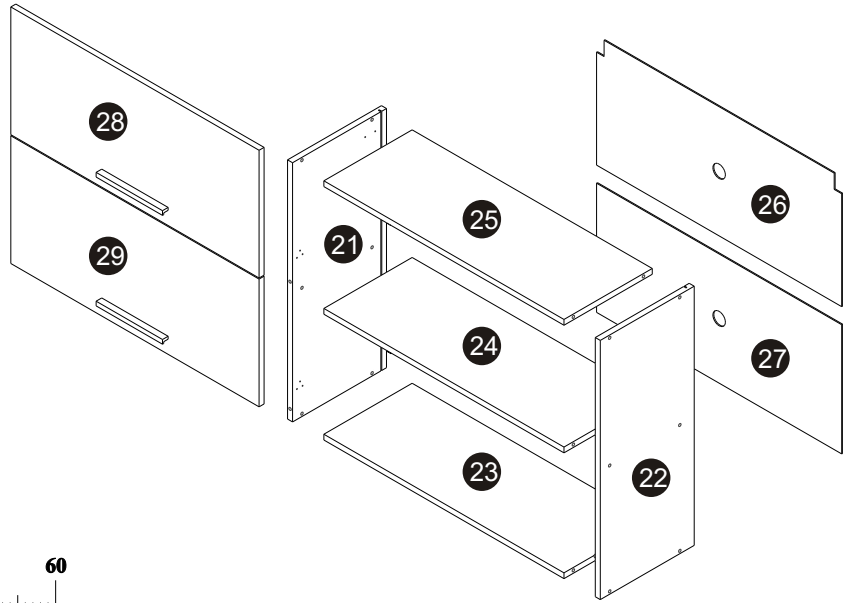

W7 X4	ZRS1 X2	LMM1 X2	KRW1 X4	KK1 X1	K1 X12
PL1 X8	W1 X24	S1 X4	WK1 X2	AM1 X2	ZK X12
WU X4	U75 X2	PG2 X4	W4 X8	ZP X2	Z1P X2

01

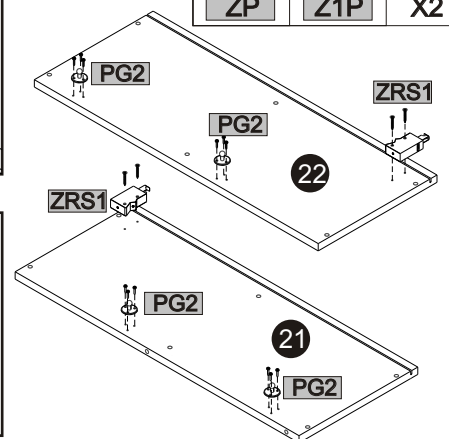
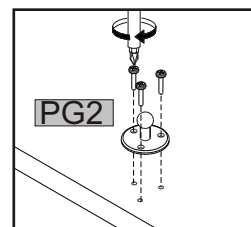
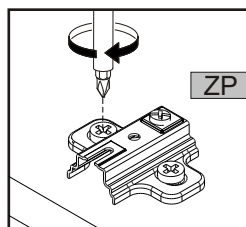
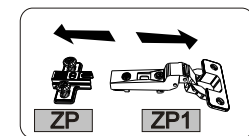
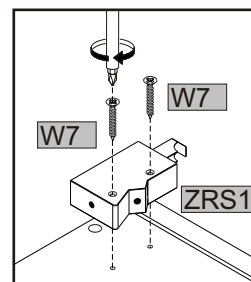
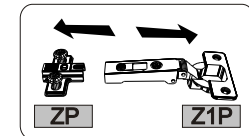
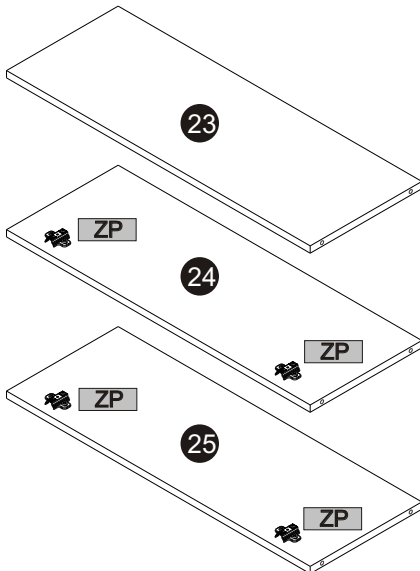
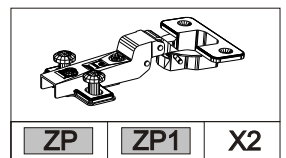
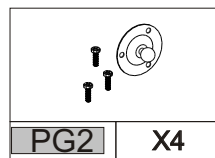
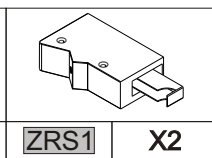
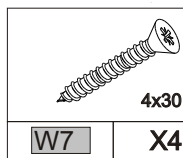
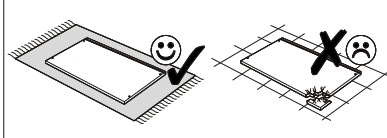

02

K1	x12	KK1	X1	ZK	X12
W1	X24	PL1	X8	S1	X4

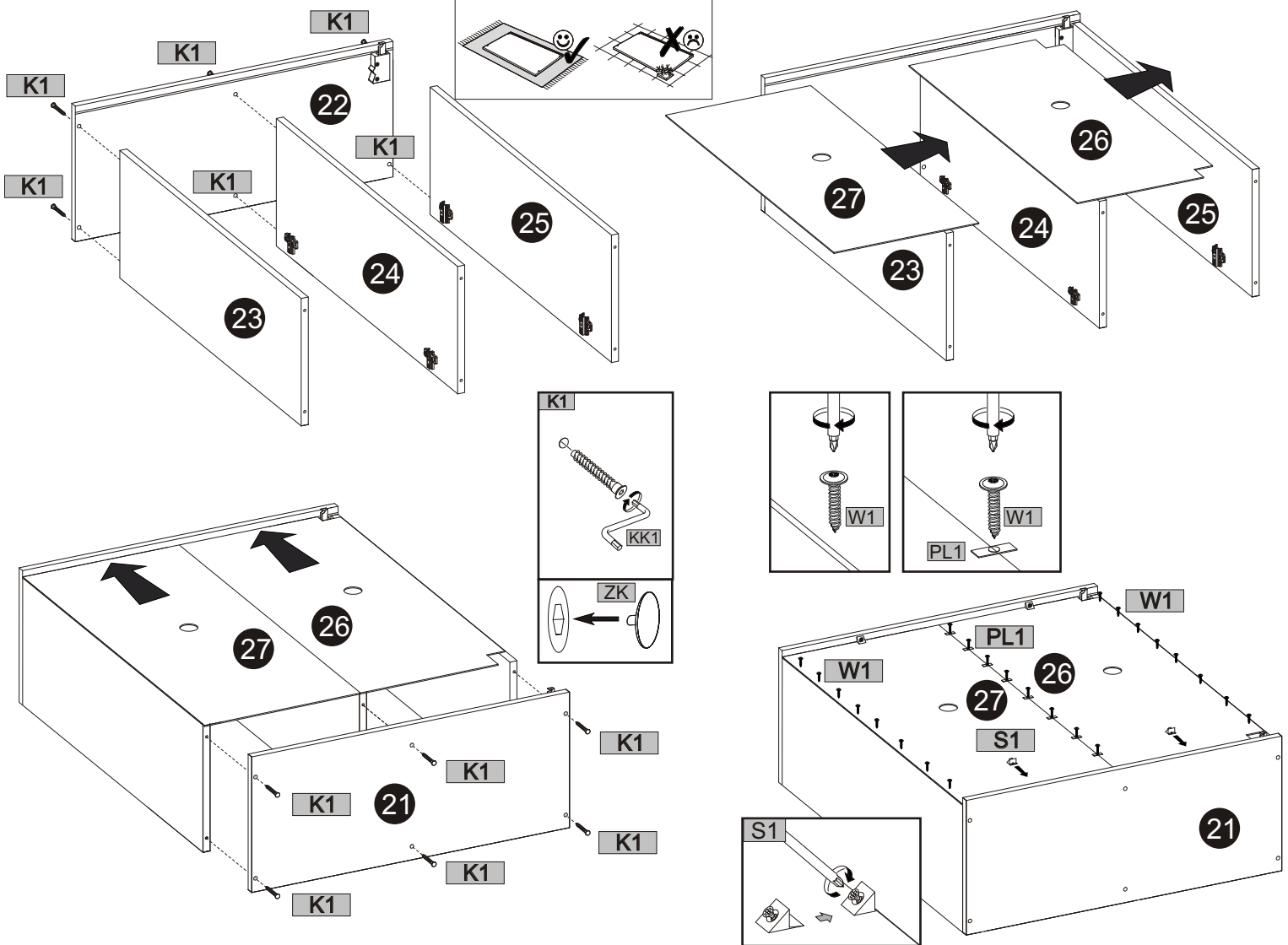

03

	PG2	x4	ZP1	X2
			Z1P	X2
			W4	X8

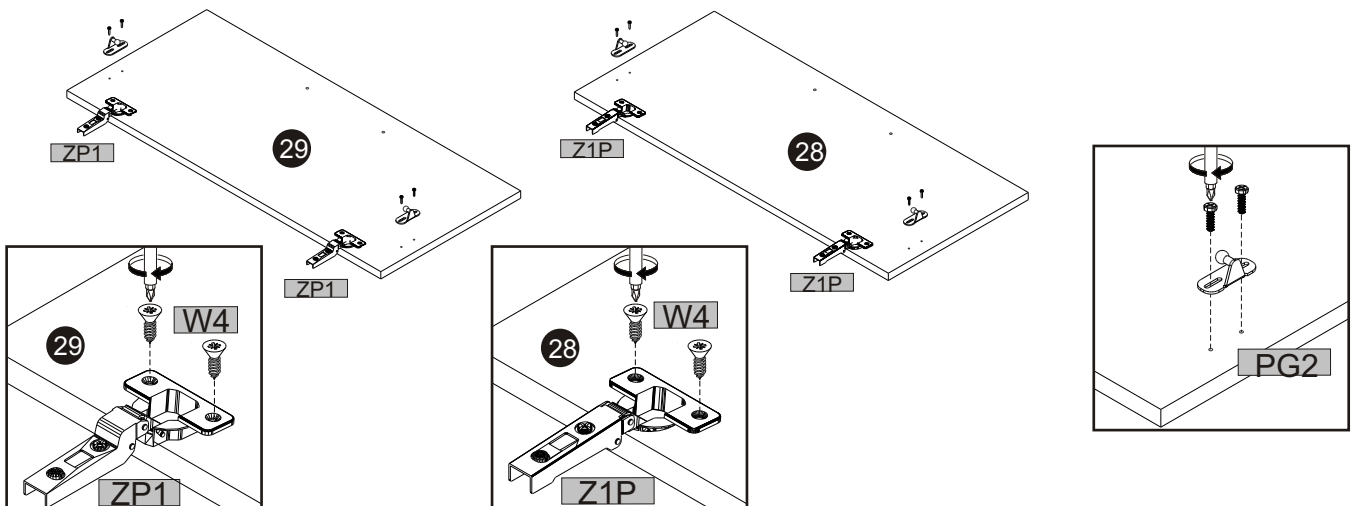

04

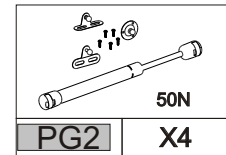
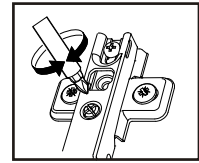
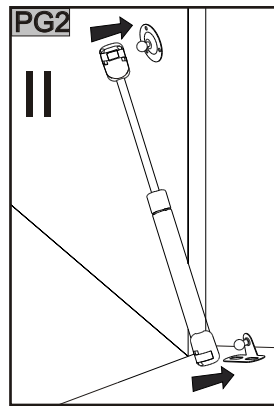
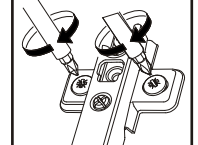
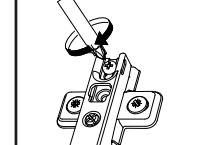
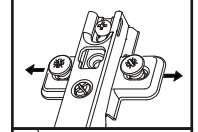
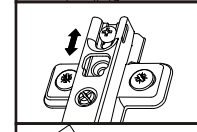
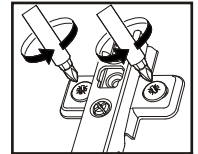
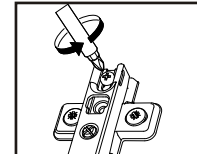
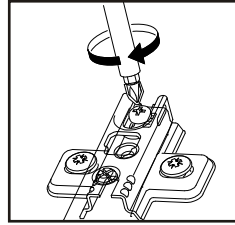
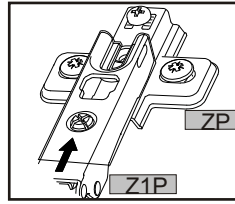
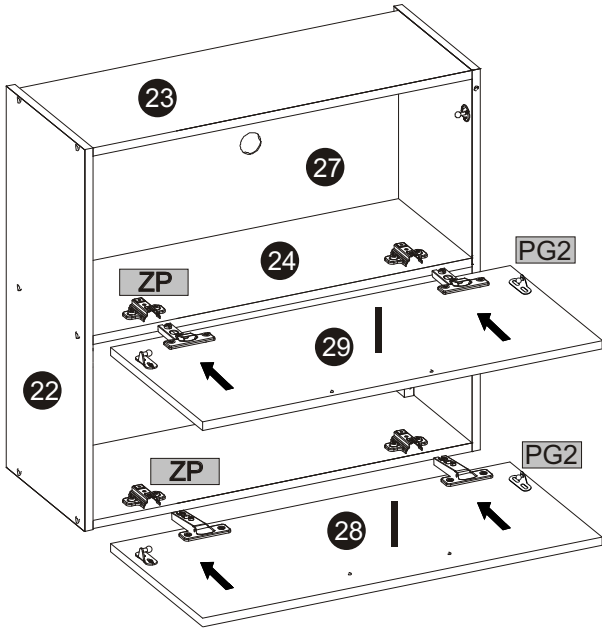
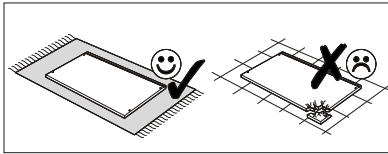

05

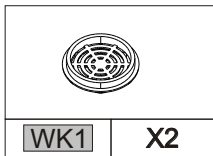

WK1 X2

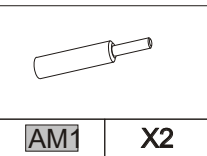

AM1 X2

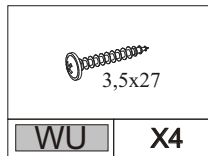

WU X4

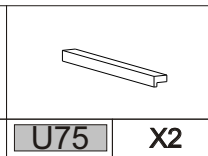

U75 X2

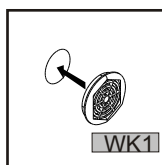
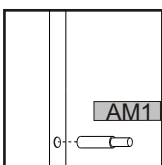
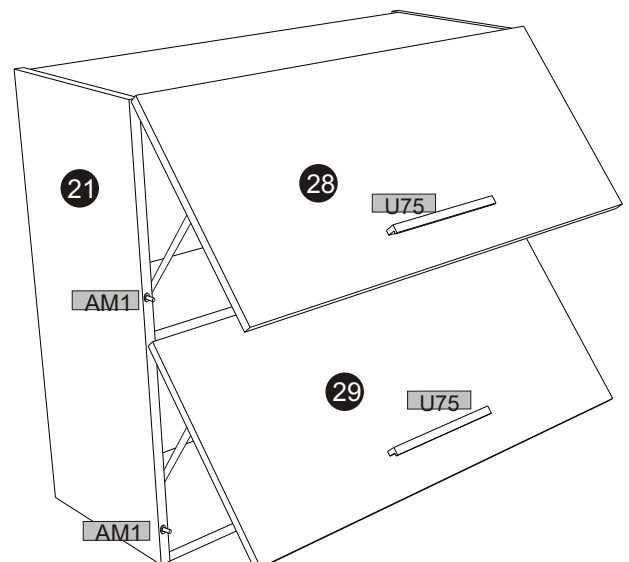
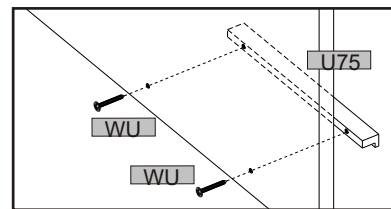
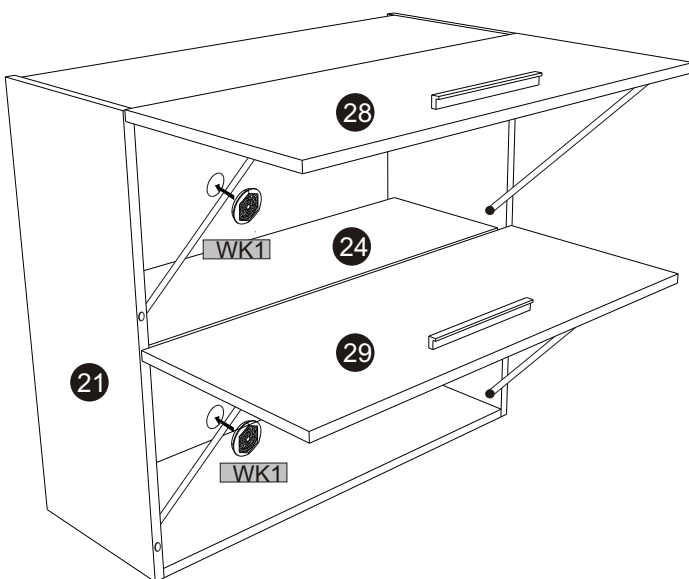
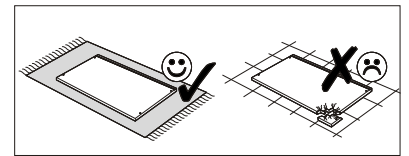

	5/6	6/6	D
30	16x717x300	X1	
31	16x717x300	X1	
32	16x567x282	X1	
33	16x567x282	X1	
34	16x567x282	X1	
35	3x355x582	X1	
36	3x355x582	X1	
37	16x353x596	X1	
38	22x353x596	X1	

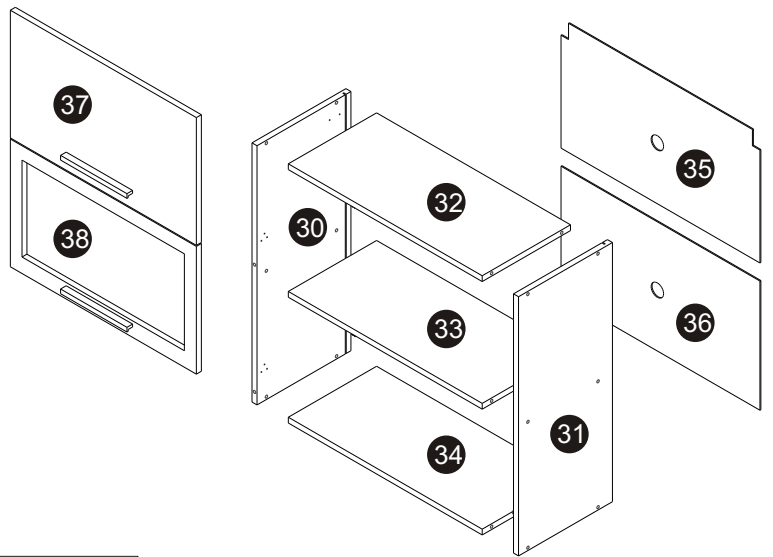

ZMP	ZMP2	X2	ZP	Z1P	X2
				W4	
				X8	

W7	X4	ZRS1	X2	LMM1	X2	KRW1	X4	KK1	X1	K1	X12
PL1	X6	W1	X18	S1	X4	WK1	X2	AM1	X2	ZK	X12

WU	X4	U75	X2	PG2	X1	PG3	X1

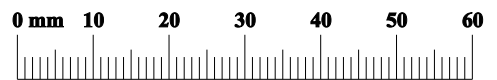

01

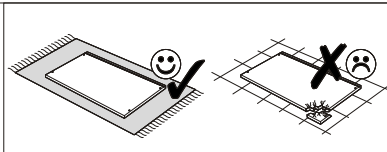

W7	X4	ZRS1	X2



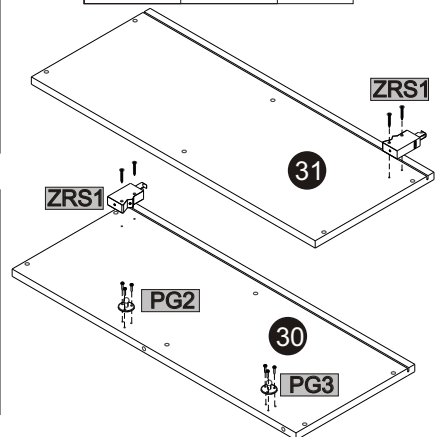
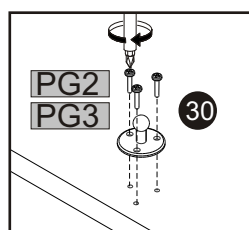
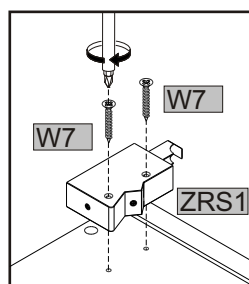
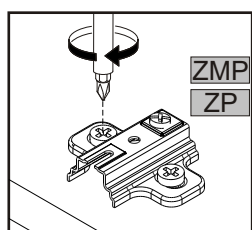
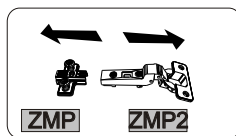
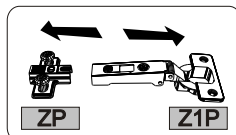
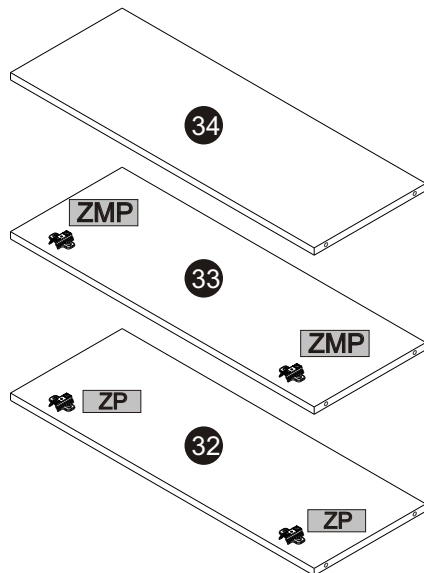

ZRS1	X2	PG2	X1
		PG3	X1

ZMP	ZMP2	X2	
ZP	Z1P	X2	

ZMP	ZMP2	X2	
ZP	Z1P	X2	

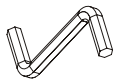

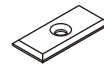

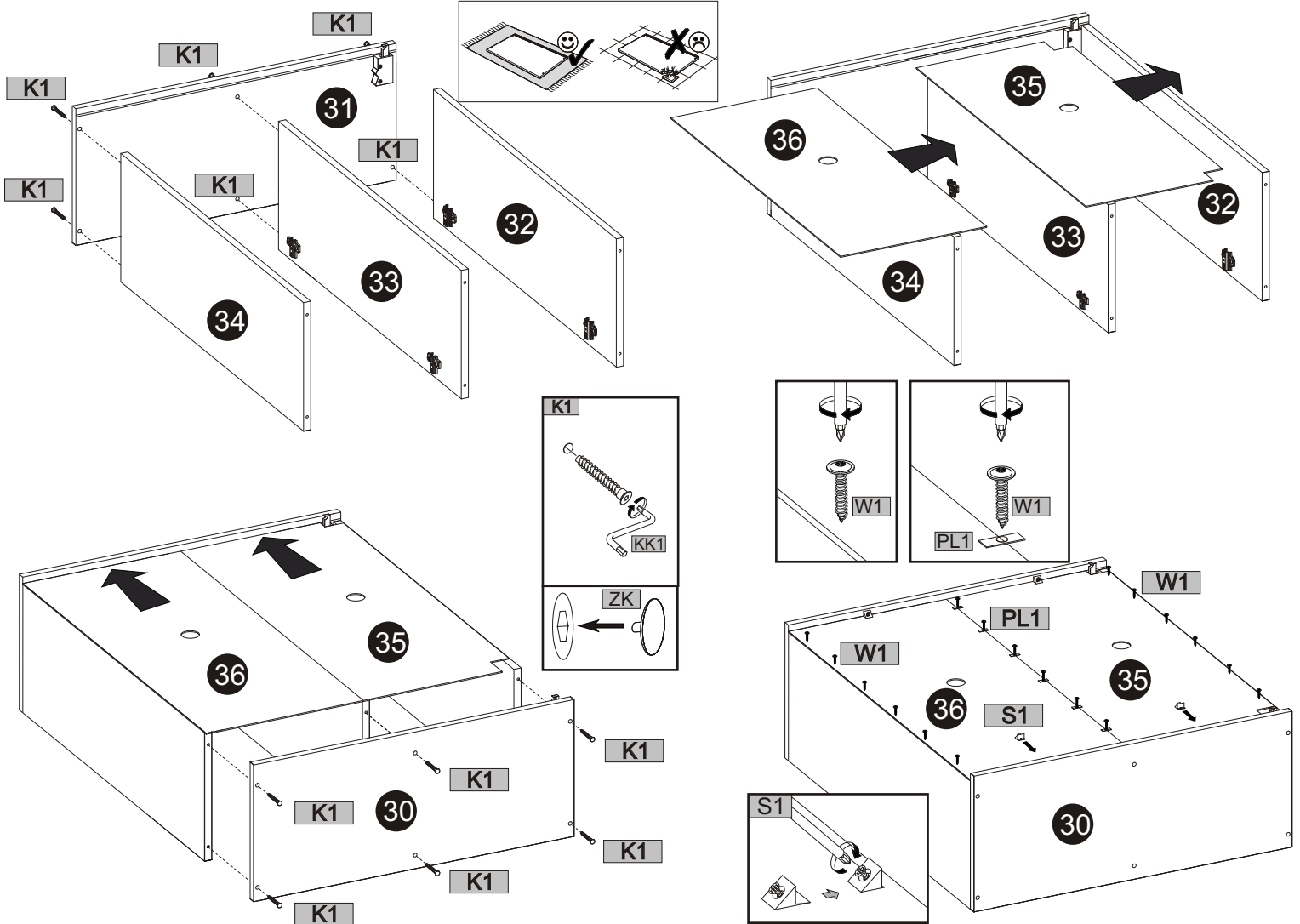

02

					
K1	x12	KK1	X1	ZK	X12
W1	X18	PL1	X6	S1	X4

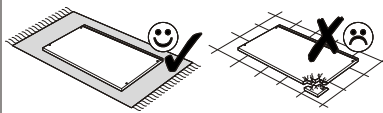

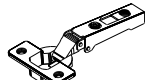
03

				
	ZMP2	Z1P	W4	PG2 X1 PG3 X1
	X2	X2	X8	

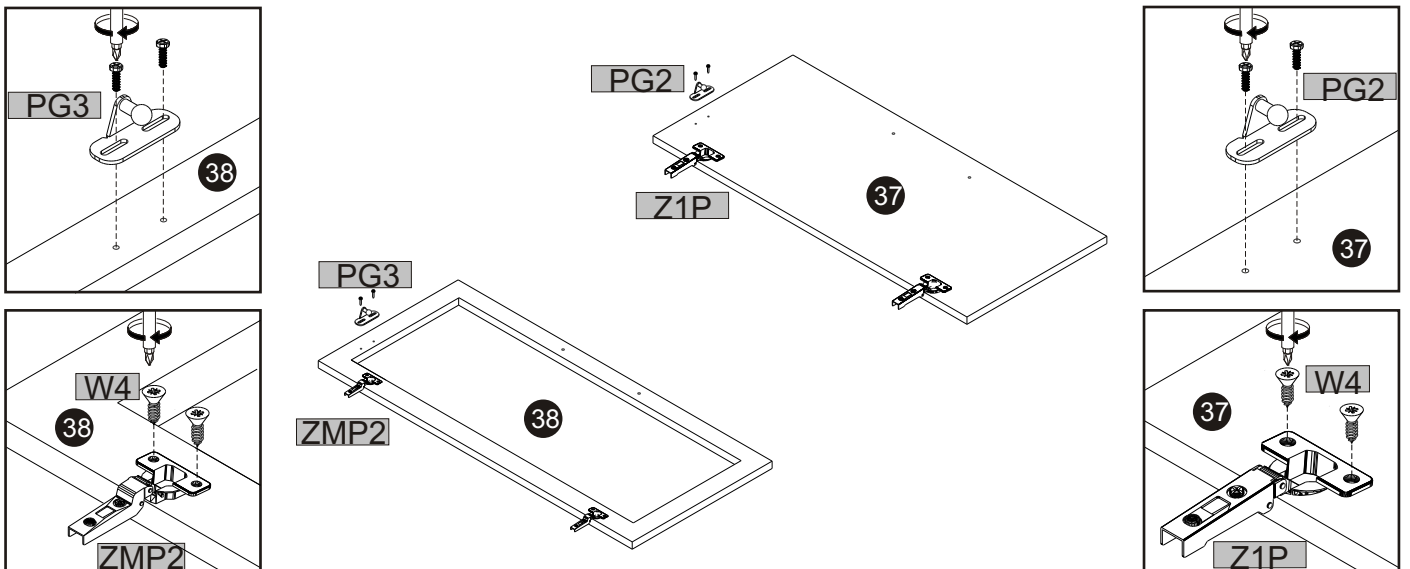

04

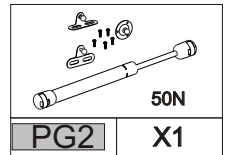
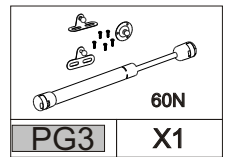
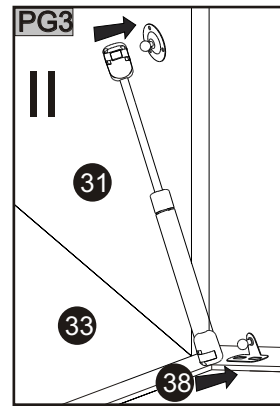
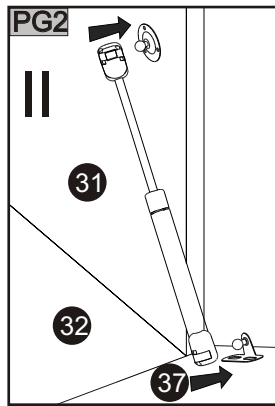
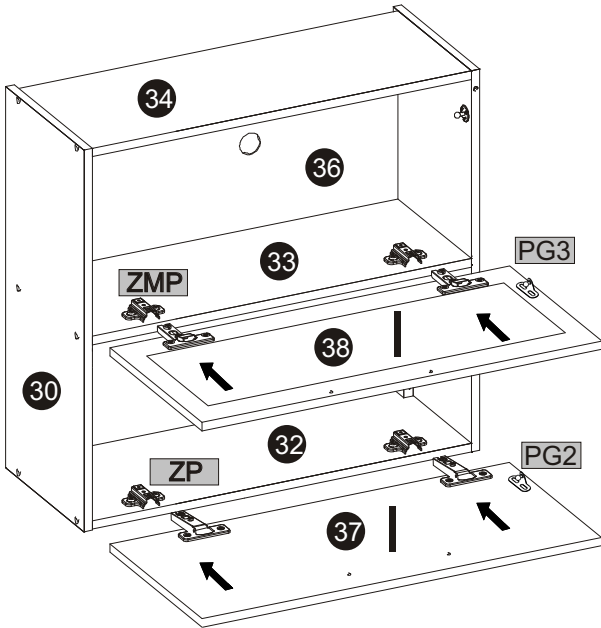
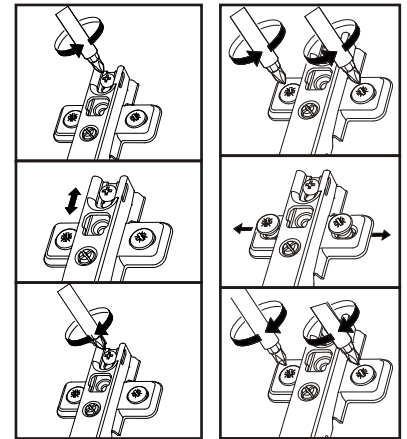
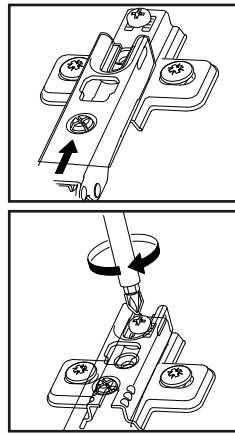
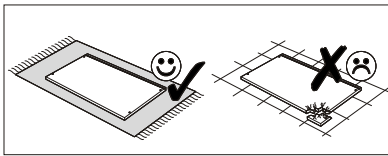

05

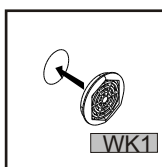
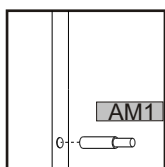
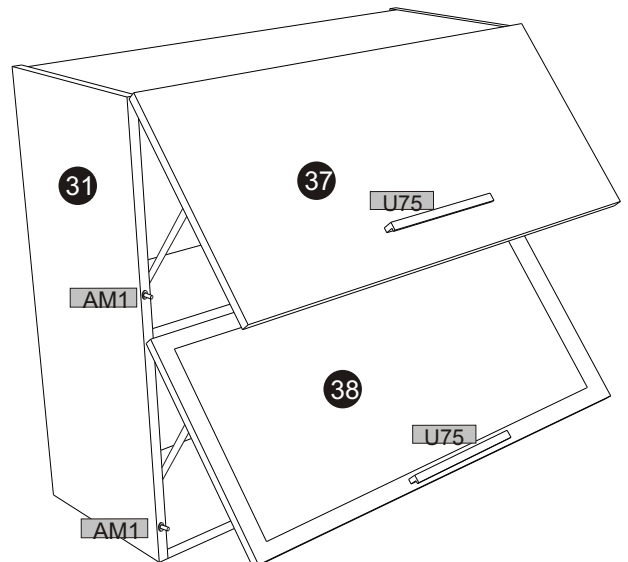
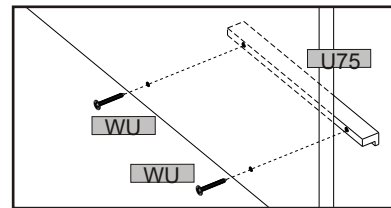
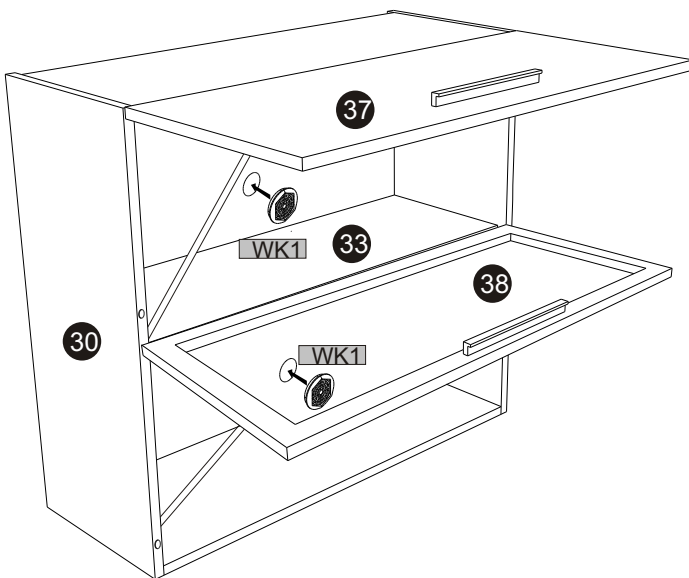
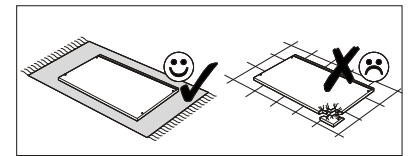
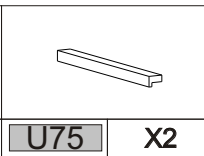
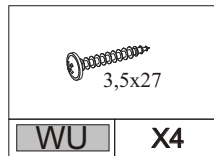
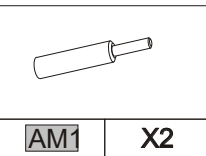
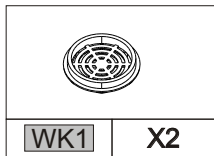

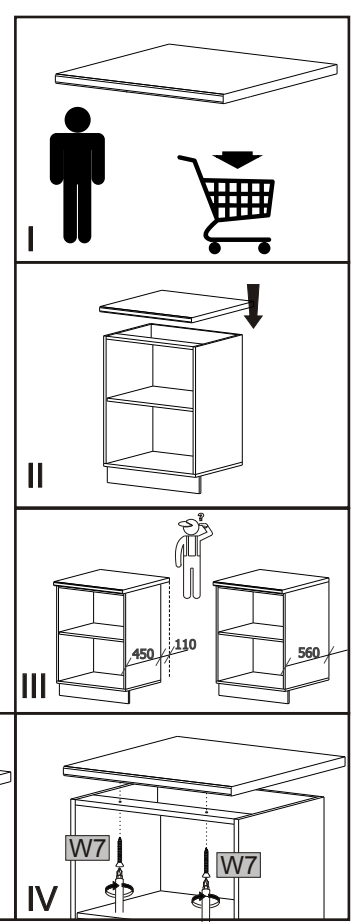
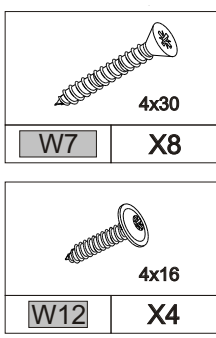
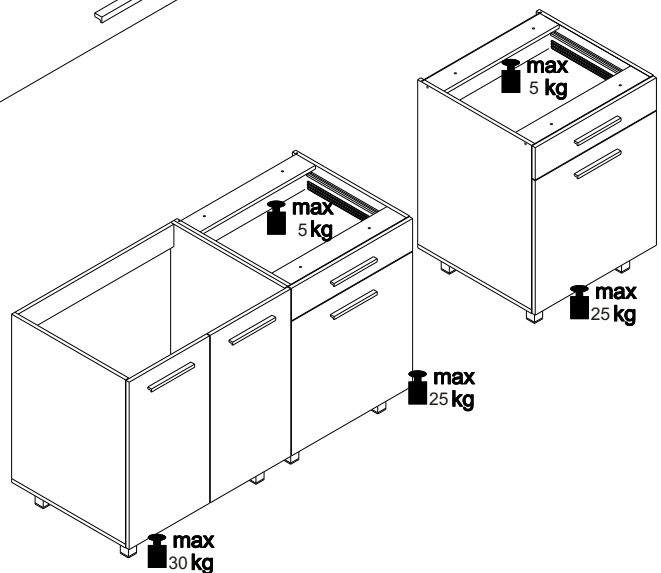
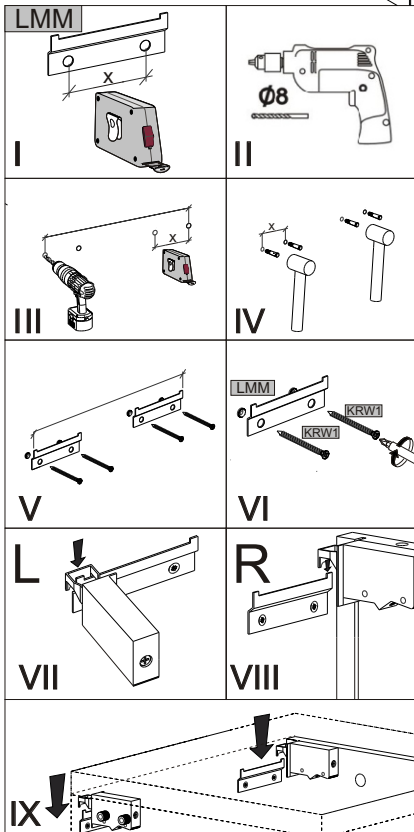
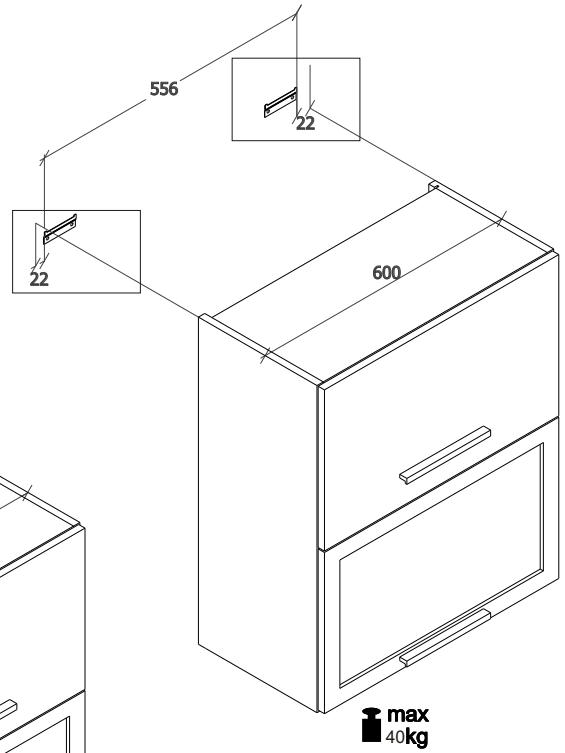
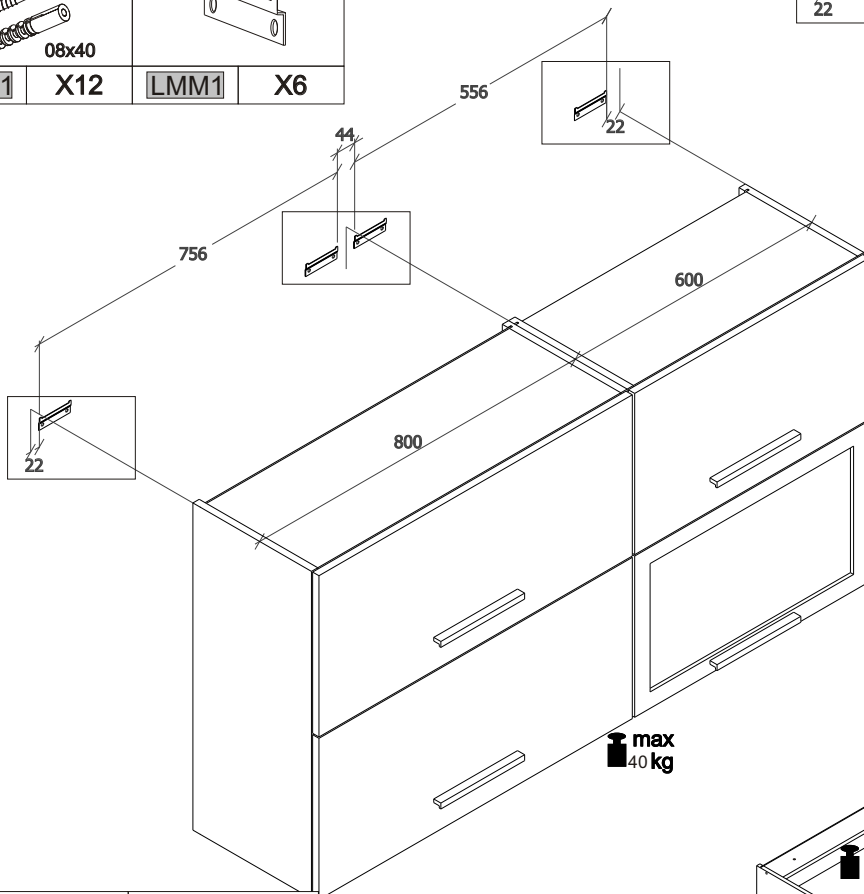
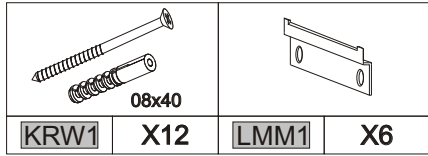
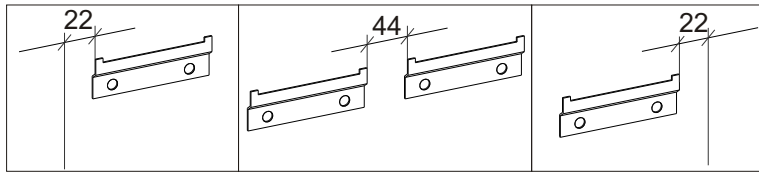

[PL] Notatki ogólne

Montaż mebli kuchennych powinien być wykonywany tylko przez osoby wykwalifikowane. Przed instalacją należy zapoznać się z instrukcją montażu. Istnieją specjalne, bardziej szczegółowe instrukcje montażu i informacje dotyczące urządzeń, zmywarek, piekarników, oświetlenia i wyposażenia specjalnego, które również należy przestrzegać.

Podczas montażu elementów ściennych należy przestrzegać następujących zasad:

- Jeśli elementy do zamocowania nie zostały dostarczone lub są nieodpowiednie do właściwości występujących ścian. Należy skontaktować się z lokalnym sprzedawcą, aby uzyskać odpowiednie kołki rozporowe / haki / szyny do zawieszania / śruby / wkręty. **No. 1 No. 2**
- Do mocowania na ścianie należy używać haczyków lub szyn.
- Szafki podwieszane mogą wytrzymać obciążenie ok. 40 kg w przypadku prawidłowego zainstalowania. Upewnij się, że ładunek jest równomiernie rozłożony.

Jeśli instrukcje nie są przestrzegane, a szafka jest zamontowana nieprawidłowo, nie ponosimy odpowiedzialności za szkody wynikłe z niewłaściwego montażu.

Pamiętaj, aby odpowiednio ustawić i powiesić szafki lub cały zestaw kuchenny, w taki sposób, aby zabezpieczyć go przed przewróceniem.

Instalacje wodne i elektryczne mogą być wykonywane tylko przez wykwalifikowanego specjalistę. **No. 3**

Przed wierceniem należy się upewnić, że w ścianie nie przebiegają żadne kable prądowe / rury gazowe, wodne, ogrzewania itp.

Przed instalacją sprawdź, czy wszystkie połączenia są prawidłowe i zostały wykonane profesjonalnie.

Kuchnia zawiera małe części, które mogą powodować niedrożność / zadławienie. Nie zostawiaj dzieci poniżej 3 lat bez opieki.

Zalecana kolejność montażu mebli kuchennych:

Zaplanuj dokładną lokalizację szafek kuchennych, biorąc pod uwagę podłączenie wody i elektryczności. Sprawdź, czy lodówka / zamrażarka wymaga wylotów powietrza w podstawie lub na powierzchni. **No. 4**

Zakup w specjalistycznym sklepie odpowiednie kratki wentylacyjne jeśli nie są dołączone i wytnij otwory w podłożu lub/i blacie zgodnie z instrukcją producenta urządzenia. Zdecyduj, czy drzwi będą się otwierać w prawo lub w lewo. **No. 5**

Najpierw zainstaluj szafki wiszące. Dokładnie wyznacz położenie otworów montażowych. Wywierć i zamontuj elementy mocowania (haki/listwa montażowa). Zamontuj szafki i wyrównaj ich poziom przy użyciu poziomicy. Połącz poszczególne szafki za pomocą śrub. Dla ułatwienia, zalecamy stosowanie dwóch ścisków śrubowych. Ustaw, ściśnij i skręć. **No. 6**

Ustaw szafki dolne, wyrównaj poziom i połącz ze sobą podobnie jak w szafkach wiszących.

Umieść blat na szafkach, wyrównaj go. Zaznacz położenie i szerokość szafki do zabudowy piekarnika i zlewu. **No. 7**

Na spodniej stronie blatu za pomocą szablonów dołączonych do urządzeń wyznacz miejsca otworów do wycięcia. Szablony ustaw w taki sposób, aby zlew znajdował się w środku szafki, a szerokość panelu pozostała taka sama z przodu i z tyłu. **No. 8**

Wywierć otwór o średnicy 10 mm w każdym z czterech narożników zaznaczonego obszaru, aby ułatwić włożenie wyżynarki a następnie wyciąć wzdłuż oznakowania. Zawsze pracuj na spodniej części blatu, tak aby piła nie uszkodziła powierzchni zewnętrznej blatu. **No. 9**

Powierzchnie cięte powinny być zabezpieczone przed nasiąkaniem wilgocią.

Miejsce styku blatu ze ścianą uszczelnić za pomocą silikonu lub listwy przyblatowej. **No. 10**

[EN] General notes

The assembly of kitchen furniture should only be carried out by qualified staff. Before starting the installation, read the assembly instructions. There are special, more detailed installation instructions and information about appliances, dishwashers, ovens, lighting and special equipment that also need to be followed.

When mounting wall components, the following rules must be followed:

- If the fastening elements are not supplied or are not suitable for the properties of the existing walls, please contact your local retailer to obtain the appropriate wall studs / hooks / suspension rails / screws / bolts. **No. 1 No. 2**

- Use hooks or rails for wall mounting.

- Hanging cabinets can withstand a load of approx. 40 kg if they have been installed properly. Make sure that the load is equally distributed.

If the instructions are not followed and the cabinet is installed incorrectly, we are not liable for damages resulting from incorrect assembly.

Remember to set up and hang cabinets or the entire kitchen set in such a way as to prevent it from tipping over.

Water and electrical installations may only be carried out by a qualified specialist. **No. 3**

Before drilling, make sure that there are no electricity wires / gas pipes, water pipes, heating, etc. in the wall.

Before installation, check that all connections are correct and have been made professionally.

The kitchen set contains small parts that can cause obstruction / choking. Do not leave children under 3 years of age unattended.

Recommended order of assembly kitchen furniture:

Plan the exact location of your kitchen cabinets, taking into account the water and electricity supply. **No. 4**

Check that the fridge/freezer requires air outlets in the base or on the surface.

Purchase the appropriate ventilation grilles from a specialist shop if not included and cut out the holes in the base and/or worktop according to the manufacturer's instructions. Decide whether the door will open to the right or left. **No. 5**

First install the hanging cabinets. Determine the exact position of the mounting holes. Drill and install the fastening elements (hooks / mounting rails). Mount the cabinets and level them using a spirit level. Connect the individual cabinets with screws. For ease of reference, we recommend using two screw clamps. Set, tighten and twist. **No. 6**

Position the bottom cabinets, level the level and connect them like in the wall cabinets.

Place the worktop on the cabinets, align it. Mark the position and width of the built-in oven and sink cabinet. **No. 7**

On the underside of the worktop, use the templates provided with the devices to mark out the holes to be cut out. Set the templates so that the sink is in the middle of the cabinet and the width of the panel remains the same at the front and back. **No. 8**

Drill a 10 mm diameter hole in each of the four corners of the marked area to make it easier to insert the cutter and then cut it out along the marking. Always work on the underside of the worktop so that the saw does not damage the outer surface of the worktop.

The cut surfaces should be protected against moisture absorption. **No. 9**

Seal the area of contact between the worktop and the wall with silicone or a skirting board. **No. 10**

[DE] ALLGEMEINE HINWEISE

Die Montage von Küchenmöbeln sollte nur von qualifiziertem Personal durchgeführt werden. Lesen Sie vor Beginn der Installation die Montageanleitung. Es gibt spezielle, detailliertere Installationsanweisungen und Informationen über Geräte, Geschirrspüler, Öfen, Beleuchtung und Sonderausstattungen, die ebenfalls zu beachten sind.

Bei der Montage von Wandbauteilen sind folgende Regeln zu beachten:

- Wenn die Befestigungselemente nicht geliefert werden oder für die Eigenschaften der vorhandenen Wände nicht geeignet sind, bitte wenden Sie sich an Ihren Händler vor Ort, um die entsprechenden Wandbolzen / Haken / Montageschienen / Schrauben / Bolzen zu erhalten.
- Verwenden Sie für die Wandmontage Haken oder Schienen, **No. 1 No. 2**
- Hängeschränke können bei sachgemäßer Montage eine Last von ca. 40 kg aufnehmen. Achten Sie auf eine gleichmäßige Lastverteilung.

Bei Nichtbeachtung der Anweisungen und falscher Montage des Schrankes haften wir nicht für Schäden, die durch unsachgemäße Montage entstehen. **No. 3**

Denken Sie daran, Schränke oder die gesamte Küchenset so aufzustellen und aufzuhängen, dass ein Umkippen verhindert wird. Wasser- und Elektroinstallationen dürfen nur von einem qualifizierten Fachmann durchgeführt werden. Achten Sie vor dem Bohren darauf, dass sich keine Stromkabel / Gasleitungen, Wasserleitungen, Heizungen usw. in der Wand befinden. Überprüfen Sie vor der Installation, ob alle Anschlüsse korrekt und fachgerecht ausgeführt wurden.

Der Küchensatz enthält Kleinteile, die zu Verstopfungen / Erstickungen führen können. Lassen Sie Kinder unter 3 Jahren nicht unbeaufsichtigt.

EMPFOHLENE REIHENFOLGE DER MONTAGEKÜCHENMÖBEL:

Planen Sie den genauen Standort Ihrer Küchenschränke unter Berücksichtigung der Wasser- und Stromversorgung. Überprüfen Sie, ob der Kühl-/Gefrierschrank Luftauslässe im Boden oder an der Oberfläche benötigt. Kaufen Sie die entsprechenden Lüftungsgitter, falls nicht im Lieferumfang enthalten, im Fachhandel und schneiden Sie die Löcher in Boden und/oder Arbeitsplatz nach den Angaben des Herstellers aus. Entscheiden Sie, ob sich die Tür nach rechts oder links öffnet. **No. 5**

Montieren Sie zunächst die Hängeschränke. Bestimmen Sie die genaue Position der Befestigungslöcher. Bohren und montieren Sie die Befestigungselemente (Haken / Montageschienen). Montieren Sie die Schränke und richten Sie sie mit einer Wasserwaage aus. Verbinden Sie die einzelnen Schränke mit Schrauben. Zur besseren Orientierung empfehlen wir die Verwendung von zwei Schraubzwingen. Setzen, festziehen und verdrehen. **No. 6**

Positionieren Sie die Unterschränke, richten Sie die Ebene aus und verbinden Sie sie wie in den Hängeschränken. Stellen Sie die Arbeitsplatte auf die Schränke, richten Sie sie aus. Markieren Sie die Position und Breite des Einbaubackofens und des Spültischs. **No. 7**

Verwenden Sie auf der Unterseite der Arbeitsplatte die mit den Geräten mitgelieferten Schablonen, um die zu schneidenden Löcher zu markieren. Stellen Sie die Schablonen so ein, dass sich die Spüle in der Mitte des Schrankes befindet und die Breite der Platte vorne und hinten gleich bleibt. Bohren Sie in jede der vier Ecken des markierten Bereichs ein Loch mit einem Durchmesser von 10 mm, um das Einsetzen des Fräsers zu erleichtern und schneiden Sie es dann entlang der Markierung aus. Arbeiten Sie immer an der Unterseite der Arbeitsplatte, damit die Säge die Außenfläche der Arbeitsplatte nicht beschädigt. Die Schnittflächen sind vor Feuchtigkeit aufzunehmen zu schützen. Den Kontaktbereich zwischen Arbeitsplatte und Wand mit Silikon oder einer Sockelleiste abdichten. **No. 9 No. 10**

[ES] INDICACIONES GENERALES

El montaje de los muebles de cocina debe ser realizado únicamente por personal cualificado. Antes de iniciar la instalación, lea las instrucciones de montaje. Hay instrucciones de instalación especiales y más detalladas e información sobre electrodomésticos, lavavajillas, hornos, iluminación y equipos especiales que también deben seguirse.

Cuando se montan componentes de pared, se deben seguir las siguientes reglas:

- Si los elementos de fijación no se suministran o no son adecuados para las propiedades de las paredes existentes, póngase en contacto con su distribuidor local para obtener los pernos de fijación / ganchos / rieles de suspensión / tornillos / pernos adecuados. **No. 1 No. 2**
- Utilice ganchos o rieles para el montaje en la pared.
- Los armarios colgantes pueden soportar una carga de aprox. 40 kg si se han instalado correctamente. Asegúrese de que la carga esté distribuida equitativamente.

Si no se siguen las instrucciones y el armario no se instala correctamente, no nos hacemos responsables de los daños resultantes de un montaje incorrecto. **No. 3**

Recuerde colocar y colgar los gabinetes o todo el juego de la cocina de tal manera que se evite que se vuelque. Las instalaciones de agua y eléctricas sólo pueden ser realizadas por un especialista cualificado. Antes de taladrar, asegúrese de que no haya cables de electricidad/gas, tuberías de agua, calefacción, etc. en la pared.

Antes de la instalación, compruebe que todas las conexiones son correctas y que se han realizado de forma profesional.

El juego de cocina contiene piezas pequeñas que pueden causar obstrucción / asfixia. No deje desatendidos a los niños menores de 3 años de edad.

ORDEN DE MONTAJE RECOMENDADO DE LOS MUEBLES DE COCINA:

Planifique la ubicación exacta de sus gabinetes de cocina, teniendo en cuenta el suministro de agua y electricidad. Compruebe que la nevera/congelador requiere salidas de aire en la base o en la superficie. Adquiera las rejillas de ventilación adecuadas en un taller especializado si no están incluidas y corte los orificios en la base y/o encimera de acuerdo con las instrucciones del fabricante. Decida si la puerta se abrirá a la derecha o a la izquierda. **No. 4**

Primero instale los armarios colgantes. Determine la posición exacta de los orificios de montaje. Taladrar e instalar los elementos de fijación (ganchos / carriles de montaje). Montar los armarios y nivelarlos con un nivel de burbuja. Conecte los armarios individuales con tornillos. Para facilitar la referencia, recomendamos utilizar dos abrazaderas de tornillo. Colocar, apretar y retorcer. Coloque los armarios inferiores, nivele el nivel y conéctelos como en los armarios de pared. Coloque la encimera sobre los armarios y alinéelos. Marque la posición y el ancho del gabinete integrado del horno y el fregadero. **No. 6**

En la parte inferior de la encimera, utilice las plantillas suministradas con los dispositivos para marcar los orificios que se van a cortar. Coloque las plantillas de manera que el fregadero quede en el centro del gabinete y el ancho del panel siga siendo el mismo en la parte delantera y trasera. Taladre un agujero de 10 mm de diámetro en cada una de las cuatro esquinas del área marcada para facilitar la inserción de la cuchilla y luego recortarla a lo largo de la marca. Trabaje siempre en la parte inferior de la encimera para que la sierra no dañe la superficie exterior de la encimera. **No. 7**

Las superficies cortadas deben estar protegidas contra la absorción de humedad. Selle la zona de contacto entre la encimera y la pared con silicona o rodapié. **No. 9 No. 10**

[FR] REMARQUES GÉNÉRALES

Le montage des meubles de cuisine ne doit être effectué que par du personnel qualifié. Avant de commencer l'installation, lisez les instructions de montage. Il y a des instructions d'installation spéciales plus détaillées et des informations sur les appareils électroménagers, les lave-vaisselle, les fours, l'éclairage et l'équipement spécial qui doivent également être suivis.

Lors du montage des composants muraux, les règles suivantes doivent être respectées:

- Si les éléments de fixation ne sont pas fournis ou ne sont pas adaptés aux propriétés des murs existants, veuillez contacter votre revendeur local pour obtenir les montants / crochets / rails de suspension / vis / boulons appropriés. **No. 1 No. 2**
- Utilisez des crochets ou des rails pour le montage mural.
- Les armoires suspendues peuvent supporter une charge d'environ 40 kg si elles ont été installées correctement. S'assurer que la charge est répartie également.

Si les instructions ne sont pas respectées et si l'armoire n'est pas installée correctement, nous ne sommes pas responsables des dommages résultant d'un montage incorrect. N'oubliez pas d'installer et d'accrocher les armoires ou l'ensemble de la cuisine de manière à éviter qu'elle ne se renverse. Les installations hydrauliques et électriques ne doivent être effectuées que par un spécialiste qualifié. Avant de forer, assurez-vous qu'il n'y a pas de fils électriques / tuyaux de gaz, tuyaux d'eau, chauffage, etc. dans le mur. **No. 3**

Avant l'installation, vérifiez que tous les raccordements sont corrects et ont été effectués par des professionnels. L'ensemble de cuisine contient de petites pièces qui peuvent causer des obstructions/étouffements. Ne laissez pas les enfants de moins de 3 ans sans surveillance.

COMMANDE RECOMMANDÉE POUR LE MONTAGE DE MEUBLES DE CUISINE:

Planifiez l'emplacement exact de vos armoires de cuisine en tenant compte de l'approvisionnement en eau et en électricité. Vérifiez que le réfrigérateur/congélateur nécessite des sorties d'air dans la base ou sur la surface. Achetez les grilles d'aération appropriées dans un magasin spécialisé si elles ne sont pas fournies et découpez les trous dans la base et/ou le plan de travail selon les instructions du fabricant. Décidez si la porte s'ouvrira vers la droite ou vers la gauche. **No. 4**

Installez d'abord les armoires suspendues. Déterminez la position exacte des trous de fixation. Percer et monter les éléments de fixation (crochets / rails de montage). Monter les armoires et les mettre à niveau à l'aide d'un niveau à bulle. Raccordez les différentes armoires à l'aide de vis. Pour faciliter la consultation, nous vous recommandons d'utiliser deux serre-joints à vis. Placer, serrer et tordre. Positionner les armoires inférieures, niveler le niveau et les raccorder comme dans les armoires murales. Placez le plan de travail sur les armoires, alignez-le. Marquez la position et la largeur du four encastré et de l'évier. **No. 6**

Sur la face inférieure du plan de travail, utilisez les gabarits fournis avec les appareils pour marquer les trous à découper. Placez les gabarits de façon à ce que l'évier soit au milieu de l'armoire et que la largeur du panneau reste la même à l'avant et à l'arrière. **No. 7**

Percer un trou de 10 mm de diamètre dans chacun des quatre coins de la zone marquée pour faciliter l'insertion du cutter et découpez-le ensuite le long du marquage. Travaillez toujours sur la face inférieure du plan de travail afin que la scie n'endommage pas la surface extérieure du plan de travail. Les surfaces de coupe doivent être protégées contre l'absorption d'humidité. Scellez la zone de contact entre le plan de travail et le mur avec du silicone ou une plinthe. **No. 9 No. 10**

[NL] ALGEMENE OPMERKINGEN

De montage van keukenmeubelen mag alleen door gekwalificeerd personeel worden uitgevoerd. Lees de montagehandleiding voordat u met de installatie begint. Er zijn speciale, meer gedetailleerde installatie-instructies en informatie over apparaten, vaatwassers, ovens, verlichting en speciale apparatuur die ook moeten worden gevolgd.

Bij de montage van wandcomponenten moeten de volgende regels in acht worden genomen:

- Als de bevestigingselementen niet worden geleverd of niet geschikt zijn voor de eigenschappen van de bestaande muren, neem dan contact op met uw plaatselijke verdeler om de juiste muurbestijgingselementen / haken / ophangrails / schroeven / bouten te verkrijgen. **No. 1 No. 2**
- Gebruik haken of rails voor wandmontage.
- Hangkasten kunnen een belasting van ca. 40 kg weerstaan als ze op de juiste wijze zijn geïnstalleerd. Zorg voor een gelijkmatige verdeling van de belasting.

Als de instructies niet worden opgevolgd en de kast verkeerd wordt geïnstalleerd, zijn wij niet aansprakelijk voor schade die het gevolg is van een verkeerde montage. **No. 3**

Vergeet niet om kasten of de hele keukenset zo op te zetten en op te hangen dat deze niet kunnen kantelen. Water- en elektrische installaties mogen alleen door een gekwalificeerde specialist worden uitgevoerd. Controleer voor het boren of er geen elektriciteitsdraden/gasleidingen, waterleidingen, verwarming, enz. in de muur zitten. Controleer voor de installatie of alle aansluitingen correct zijn en professioneel zijn uitgevoerd. De keukenset bevat kleine onderdelen die obstructie / verstikking kunnen veroorzaken. Laat kinderen onder de 3 jaar niet zonder toezicht achter.

AANBEVOLEN VOLGORDE VAN MONTAGE KEUKENMEUBELAIR:

Plan de exacte locatie van uw keukenset, rekening houdend met de water- en elektriciteitsvoorziening. Controleer of de koelkast/vriezer luchtuitgangen in de bodem of op het oppervlak nodig heeft. Koop de juiste ventilatieroosters in een speciaalzaak indien niet inbegrepen en snijd de gaten in de bodem en/of het werkblad uit volgens de instructies van de fabrikant. Beslis of de deur naar rechts of naar links opengaat. **No. 4**

Installeer eerst de hangende kasten. Bepaal de exacte positie van de bevestigingsgaten. Boor en monteer de bevestigingselementen (haken / montagerails). Monteer de kasten en zet ze waterpas met behulp van een waterpas. Verbind de afzonderlijke kasten met schroeven. Voor het gemak raden wij het gebruik van twee schroefklemmen aan. Instellen, vastdraaien en verdraaien. Plaats de onderkasten, zet ze waterpas en verbind ze zoals in de wandkasten. Plaats het werkblad op de kasten, richt het uit. Markeer de positie en de breedte van de inbouwoven en de spoelkast. **No. 6**

Gebruik de sjablonen aan de onderzijde van het werkblad om de uit te snijden gaten af te baken met de bij de apparaten meegeleverde sjablonen. Stel de sjablonen zo in dat de spoelbak zich in het midden van de kast bevindt en de breedte van het paneel aan de voor- en achterzijde gelijk blijft. Boor in elk van de vier hoeken van het gemarkeerde gebied een gat met een diameter van 10 mm om het gemakkelijker te maken de snijplotter in te brengen en snijd deze vervolgens uit langs de markering. Werk altijd aan de onderkant van het werkblad, zodat de zaag het buitenoppervlak van het werkblad niet beschadigt. **No. 7**

De snijvlakken moeten worden beschermd tegen vochtabsorptie. De contactvlakken tussen het werkblad en de wand moeten worden afgedicht met siliconen of een plint. **No. 9 No. 10**

<p>No. 1</p> 	<p>No. 2</p> 	<p>No. 3</p> 
<p>No. 4</p> 	<p>No. 5</p> 	<p>No. 6</p> 
<p>No. 7</p> 	<p>No. 8</p> 	<p>No. 9</p> 
<p>No. 10</p> 		